



UL INTERNATIONAL (UK) LTD
 Womersley House, Building C,
 The Guildway,
 Old Portsmouth Road,
 Guildford. GU3 1LR.
 United Kingdom.



designated according to Article 29 of the Regulation (EU) No 305/2011 and member of EOTA (European Organisation for Technical Assessment, www.eota.eu)

European Technical Assessment

**ETA 17/1048
of 21/12/2017**

Technical Assessment Body issuing the ETA and designated according to Article 29 of the Regulation (EU) No 305/2011: UL International (UK) Ltd

Trade name of the construction product

K-FLEX K-FIRE ACRYLIC

Product family to which the construction product belongs

Fire Stopping and Sealing Product:
 • Penetration Seals

Manufacturer

L'ISOLANTE K-FLEX S.p.A.
 Via Don G. Locatelli 35
 20877
 Roncello
 MB Italy

Manufacturing plant(s)

A/003

This European Technical Assessment contains

63 pages including 1 Annex which forms an integral part of this assessment.

This European Technical Assessment is issued in accordance with regulation (EU) No 305/2011, on the basis of

ETAG 026-2, edition 2011, used as European Assessment Document (EAD).

Translations of this European Technical Assessment in other languages shall fully correspond to the original issued document and should be identified as such.

Communication of this European Technical Assessment, including transmission by electronic means, shall be in full. However, partial reproduction may be made, with the written consent of the issuing Technical Assessment Body. Any partial reproduction has to be identified as such.

Table of Contents

I.	SPECIFIC PARTS OF THE EUROPEAN TECHNICAL ASSESSMENT	3
1	Technical description of the product	3
2	Specification of the intended uses of the product in accordance with the applicable European Assessment Document (Hereinafter EAD): ETAG 026-2	3
3	Performance of the product and references to the methods used for its assessment	5
4	ASSESSMENT AND VERIFICATION OF CONSTANCY OF PERFORMANCE (HEREINAFTER AVCP) SYSTEM APPLIED, WITH REFERENCE TO ITS LEGAL BASE	6
5	Technical details necessary for the implementation of the AVCP system, as provided for in the applicable EAD	6
6	Issued on:	7
	ANNEX A – Resistance to Fire Classification – K-FLEX K-FIRE ACRYLIC	8
A.1	Rigid wall constructions according to 1.2.1 with wall thickness of minimum 150 mm	8
A.1.1	Single side penetration seal with cables	8
A.1.2	Double side penetration seal with cables	9
A.1.3	Single side penetration seal with metallic (and composite) pipes	10
A.1.4	Single side penetration seal with metallic (and composite) pipes	12
A.1.5	Single side penetration seal with metallic pipes	14
A.1.6	Double side penetration seal with metallic pipes	16
A.1.7	Double side penetration seal with metallic pipes	18
A.1.8	Double side penetration seal with metallic pipes with combustible insulation	20
A.1.9	Double side penetration seal with plastic pipes	22
A.2	Flexible wall constructions according to 2. 2) with wall thickness of minimum 75 mm	24
A.2.1	Double side penetration seal with cables	24
A.3	Flexible wall constructions according to 2. 2) with wall thickness of minimum 100 mm	28
A.3.1	Double side penetration seal with cables	28
A.3.2	Double side penetration seal with metallic pipes	29
A.3.3	Double side penetration seal with metallic pipes	32
A.3.4	Double side penetration seal with composite pipes	36
A.3.5	Double side penetration seal with metallic (and composite) pipes	37
A.3.6	Double side penetration seal with plastic pipes	39
A.3.7	Double side penetration seal with plastic pipes	40
A.4	Rigid floor constructions according to 1.2.1 with floor thickness of minimum 150 mm	42
A.4.1	Single side penetration seal with cables	42
A.4.2	Single side penetration seal with cables	43
A.4.3	Single side penetration seal with pipes	44
A.4.4	Double side penetration seal with pipes	46
A.4.5	Double side penetration seal with cables	48
A.4.6	Single side penetration seal with metallic pipes	49
A.4.7	Single side penetration seal with metallic pipes	53
A.4.8	Single side penetration seal with composite pipes	55
A.4.9	Double side penetration seal with metallic pipes	56
A.4.10	Double side penetration seal with metallic pipes	57
A.4.11	Double side penetration seal with metallic pipes	60
A.4.12	Double side penetration seal with plastic pipes	62

I. SPECIFIC PARTS OF THE EUROPEAN TECHNICAL ASSESSMENT

1 Technical description of the product

- 1) K-FLEX K-FIRE ACRYLIC is a sealant used to form a penetration seal around metallic pipes, plastic pipes, composite pipes and electrical cables to reinstate the fire resistance performance of wall and floor constructions, where they have been provided with apertures for the penetration of services.
- 2) The K-FLEX K-FIRE ACRYLIC is supplied in liquid form contained within 310 & 380 ml cartridges and 600 ml foil packs. The sealant is gunned into the aperture in the separating element/elements and around the service or services, to a specified depth utilising mineral fibre insulation backing material.
- 3) K-FLEX K-FIRE ACRYLIC contains no carcinogenic substances or mutagenic substances, flame retardants or antimicrobiological agents.
- 4) The applicant has submitted a written declaration that K-FLEX K-FIRE ACRYLIC does not contain substances which have to be classified as dangerous according to Directive 67/548/EEC and Regulation (EC) No 1272/2008 and listed in the "Indicative list on dangerous substances" of the EGDS - taking into account the installation conditions of the construction product and the release scenarios resulting from there. An emission report has also been provided.

In addition to the specific clauses relating to dangerous substances contained in this European technical Assessment, there may be other requirements applicable to the products falling within its scope (e.g. transposed European legislation and national laws, regulations and administrative provisions). In order to meet the provisions of the Construction Products Regulation, these requirements need also to be complied with, when and where they apply.

- 5) The use category of K-FLEX K-FIRE ACRYLIC in relation to BWR 3 (Hygiene, health and environment) is IA1, S/W3

2 Specification of the intended uses of the product in accordance with the applicable European Assessment Document (Hereinafter EAD): ETAG 026-2

Detailed information and data is given in Annex A.

- 1) The intended use of system K-FLEX K-FIRE ACRYLIC is to reinstate the fire resistance performance of flexible wall constructions, rigid wall constructions and rigid floor constructions where they are penetrated by various metal pipe services with and without combustible insulation, plastic pipes, composite pipes and electrical cables.
- 2) The specific elements of construction that the system K-FLEX K-FIRE ACRYLIC may be used to provide a penetration seal in, are as follows:
 - a. Flexible walls: The wall must have a minimum thickness of 75 mm and comprise steel studs or timber studs* lined on both faces with minimum 1 layers of 12.5 mm thick boards.
 - b. Rigid walls: The wall must have a minimum thickness of 75 mm and comprise concrete, aerated concrete or masonry, with a minimum density of 650 kg/m³.
 - c. Rigid floors: The floor must have a minimum thickness of 150 mm and comprise aerated concrete or concrete with a minimum density of 650 kg/m³.

* no part of the penetration seal may be closer than 100 mm to a stud, the cavity must be closed between the penetration seal and the stud, and minimum 100 mm of insulation of class A1 or A2

according to EN 13501-1 must be provided within the cavity between the penetration seal and the stud.

The supporting construction must be classified in accordance with EN 13501-2 for the required fire resistance period.

- 3) The system K-FLEX K-FIRE ACRYLIC may be used to provide a penetration seal with specific single insulated metal pipes, uninsulated metal pipes, plastic pipes, composite pipes and with specific electrical cables, single or in a bundle (for details see Annex A).
- 4) Apertures in the separating element shall be maximum 300 x 300 mm or 100 x 1000 mm. The annular space/gap around the services shall be infilled with mineral fibre insulation backing material and K-FLEX K-FIRE ACRYLIC sealant. Blank seals up to 300 x 300 mm are permitted. For full details, see Annex A.
- 5) Pipes shall be supported at maximum 350 mm away from both faces of the wall constructions and from the upper face of floor constructions.
- 6) The provisions made in this European Technical Approval are based on an assumed working life of the K-FLEX K-FIRE ACRYLIC of 30 years, provided that the conditions laid down in sections 4.2/5.1/5.2 for the packaging/transport/ storage/installation/use/repair are met. The indications given on the working life cannot be interpreted as a guarantee given by the producer, but are to be regarded only as a means for choosing the right products in relation to the expected economically reasonable working life of the works.
- 7) Type Z₂: Intended for uses in internal conditions with humidity lower than 85 % RH excluding temperatures below 0°C, without exposure to rain or UV.

3 Performance of the product and references to the methods used for its assessment

Product-type: Sealant		Intended use: Penetration Seal
Basic requirement for construction work	Basic Requirement	Performance
BWR 1 Mechanical resistance and stability		
-	None	Not relevant
BWR 2 Safety in case of fire		
EN 13501-1	Reaction to fire	Class D-s1, d1
EN 13501-2	Resistance to fire	Annex A
BWR 3 Hygiene, health and environment		
EN 1026:2000	Air permeability (material property)	No performance determined
ETAG 026-2, Annex C	Water permeability (material property)	No performance determined
Declaration of manufacturer	Release of dangerous substances	Use categories: IA1, S/W3 Declaration of manufacturer
BWR 4 Safety in use		
EOTA TR 001:2003	Mechanical resistance and stability	No performance determined
EOTA TR 001:2003	Resistance to impact/movement	No performance determined
EOTA TR 001:2003	Adhesion	No performance determined
BWR 5 Protection against noise		
EN 10140-2/ EN ISO 717-1	Airborne sound insulation	No performance determined
BWR 6 Energy economy and heat retention		
EN 12664, EN 12667 or EN 12939	Thermal properties	No performance determined
EN ISO 12572 EN 12086	Water vapour permeability	No performance determined
General aspects relating to fitness for use		
EOTA TR 024:2009, clause 3.1.11 & 3.1.12	Durability and serviceability	Z ₂
BWR 7 Sustainable use of natural resources		
-	-	No performance determined

4 ASSESSMENT AND VERIFICATION OF CONSTANCY OF PERFORMANCE (HEREINAFTER AVCP) SYSTEM APPLIED, WITH REFERENCE TO ITS LEGAL BASE

According to the decision 1999/454/EC – Commission Decision of date 22nd June 1999 on the procedure for attesting the conformity of construction products pursuant to Article 20(2) of Council Directive 89/106/EEC as regards fire stopping, fire sealing and fire protective products, published in the Official Journal of the European Union (OJEU) L178/52 of 14/07/1999, see <http://eur-lex.europa.eu/JOIndex.do> of the European Commission¹, as amended, the system(s) of assessment and verification of constancy of performance (see Annex V to Regulation (EU) No 305/2011) given in the following table(s) applies (apply).

Product(s)	Intended use(s)	Level(s) or class(es)	System(s)
Fire stopping and Fire Sealing Products	For fire compartmentation and/or fire protection or fire performance	Any	1

5 Technical details necessary for the implementation of the AVCP system, as provided for in the applicable EAD

Tasks of the manufacturer:

Factory production control

The manufacturer shall exercise permanent internal control of production. All the elements, requirements and provisions adopted by the manufacturer shall be documented in a systematic manner in the form of written policies and procedures, including records of results performed. This production control system shall ensure that the product is in conformity with this European technical Assessment.

The manufacturer may only use initial / raw / constituent materials stated in the technical documentation of this European Technical Assessment.

The factory production control shall be in accordance with the Control Plan of 8th April 2013 relating to the European technical assessment ETA 17/1048 issued on 21/12/2017 which is part of the technical documentation of this European technical approval. The "Control Plan" is laid down in the context of the factory production control system operated by the manufacturer and deposited at UL International (UK) Ltd.

The results of factory production control shall be recorded and evaluated in accordance with the provisions of the Control Plan.

¹ Official Journal of the European Communities L178/52 of 14/7/1999

Other tasks of the manufacturer

Additional information

The manufacturer shall provide a technical data sheet and an installation instruction with the following minimum information:

(a) Technical data sheet:

- Field of application:
- Building elements for which the linear joint seal or penetration seal is suitable, type and properties of the building elements like minimum thickness, density, and - in case of lightweight constructions – the construction requirements.
- Limits in size, minimum thickness etc. of the joint or penetration seal
- Construction of the linear joint seal or penetration seal including the necessary components and additional products (e.g. backfilling material) with clear indication whether they are generic or specific.
- Services which the penetration seal is suitable, type and properties of the services like material, diameter, thickness etc. in case of pipes including insulation materials; necessary/allowed supports/fixings (e.g. cable trays)

(b) Installation instruction:

- Steps to be followed
- Procedure in case of retrofitting
- Stipulations on maintenance, repair and replacement

6 Issued on:

21st December 2017

Report by:



D. Yates
Project Engineer
Building and Life Safety Technologies

Reviewed by:



C. Johnson
Staff Engineer
Building and Life Safety Technologies

For and on behalf of UL International (UK) Ltd.

ANNEX A – Resistance to Fire Classification – K-FLEX K-FIRE ACRYLIC

A.1 Rigid wall constructions according to 1.2.1 with wall thickness of minimum 150 mm

A.1.1 Single side penetration seal with cables

Penetration Seal: Cables (single) fitted at any position within the aperture, with K-FLEX K-FIRE ACRYLIC to either side of the wall (or at any position in between), backed with stone wool insulation 35kg/m³ or 'AES Fibre ≥ 128kg/m³'. Minimum separation between cables and the edge of the seal of 7 mm.

Construction details:

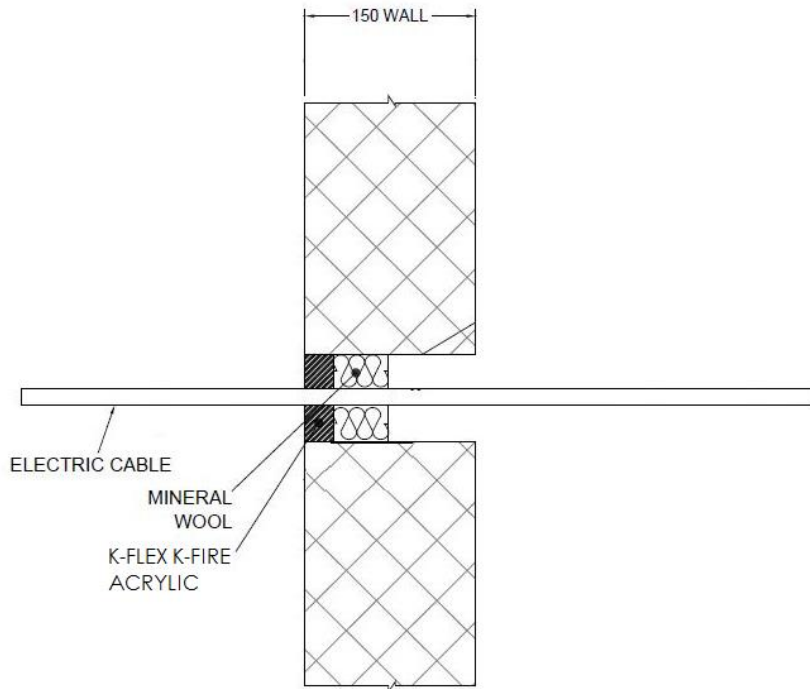

A.1.1.1

Services	Sealant depth	Backing	Maximum seal size	Classification
Single electrical cables up to 21 mm Ø	25 mm	48 mm deep AES Fibre ≥ 128kg/m ³	87 mm Ø	E 240, EI 90
Blank seals	25 mm	48 mm AES Fibre ≥ 128kg/m ³ insulation	300 x 300 mm	E 240, EI 60
Electric cables up to 21 mm diameter, single.			35 x 35 mm / 36 mm Ø	
Blank seals				E 240, EI 120
Electric cables up to 21 mm diameter, single.				

A.1.2 Double side penetration seal with cables

Penetration Seal: Cables fitted with K-FLEX K-FIRE ACRYLIC to both sides of the wall, backed with stone wool insulation 35kg/m³. Maximum seal size of 300 x 300 mm and minimum separation between cables and the edge of the seal of 10 mm.

Construction details:

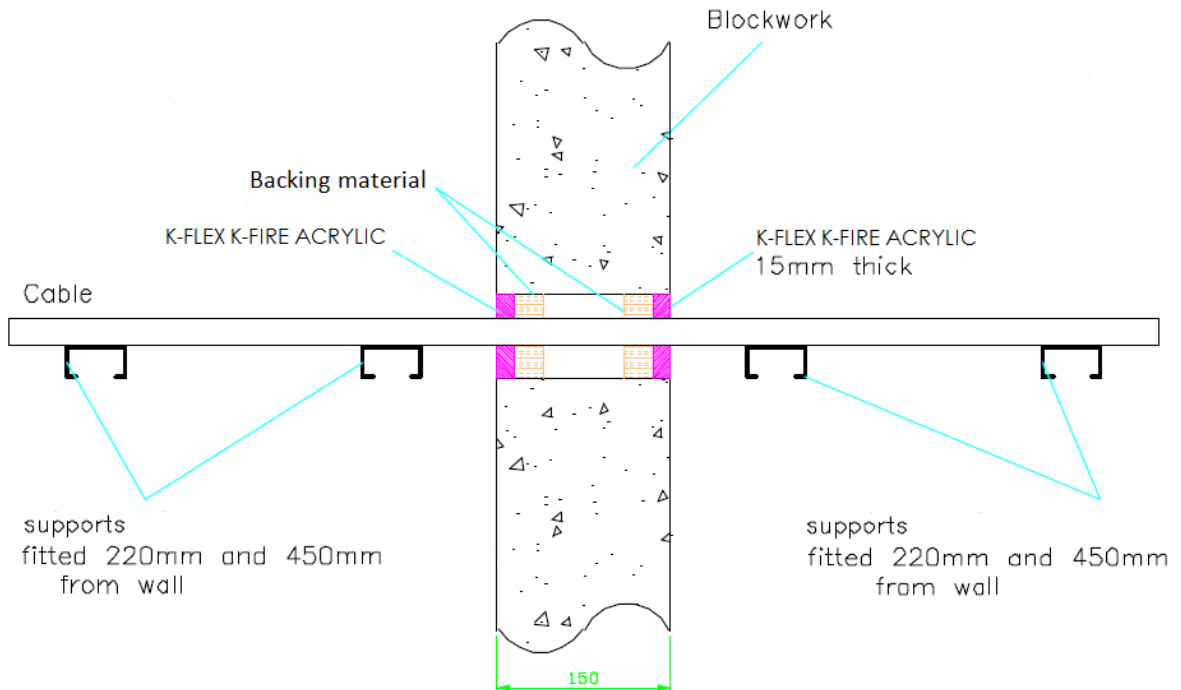

A.1.2.1

Services	Sealant depth	Backing	Insulation	Classification
Blank seals	15 mm	25 mm Stone wool 35 kg/m ³	None	EI 240
Electric cables up to 21 mm diameter, single or in a bundle.				E 240 EI 120
Electric cables 22-80 mm diameter, single or in a bundle.				E 120 EI 60
Blank seals	25 mm	48 mm AES Fibre ≥ 128kg/m ³		EI 240
Electric cables up to 80 mm diameter, single or in a bundle.				E 240 EI 60
Cables up to 21 mm diameter, single or in a bundle up to 100 mm diameter				EI 240

A.1.3 Single side penetration seal with metallic (and composite) pipes

Penetration Seal: LI (Local Interrupted) of minimum length stated below or CI (Continuous Interrupted) insulated metallic and composite pipes (single) fitted at any position within the aperture, with 15 mm deep K-FLEX K-FIRE ACRYLIC to either side of the wall (or at any position between), backed with 20 mm deep 40 kg/m³ stone wool insulation*.

Construction details:

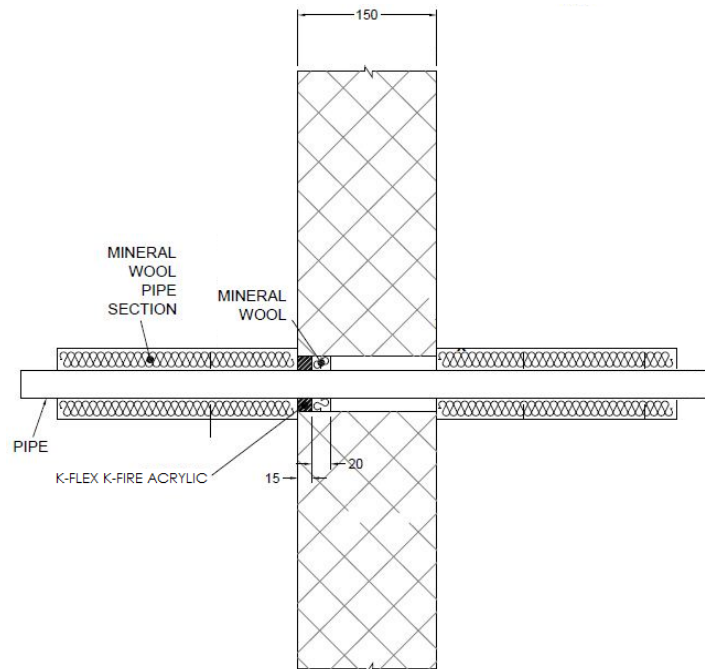

A.1.3.1

Services	Seal width around pipe	Insulation (minimum)	Classification
Copper pipe up to 54 mm diameter/0.9-14.2 mm wall	8-9 mm	1000 mm length 20 mm Stone wool insulation 80 kg/m ³	E 240 C/U, EI 180 C/U
Copper pipe up to 12 mm diameter/0.9-5 mm wall	8 mm		EI 240 C/U
Alupex composite pipe 75 mm diameter/7.5 mm wall	30 mm	25 mm AES Fibre ≥ 128kg/m ³ insulation, 600 mm long (min.)	EI 120 C/U

Services	Seal width around pipe	Insulation (minimum)	Classification
Mild or stainless steel pipe			
40 mm diameter/1.5-14.2 mm wall*	6-18 mm	1000 mm length of 20 mm Stone wool insulation 80 kg/m ³	EI 240 C/U
40 mm diameter/1.5-14.2 mm wall*		1000 mm length of 30 mm Stone wool insulation 80 kg/m ³	E 180, EI 90 C/U
50 mm diameter/1.7-14.2 mm wall*			
60 mm diameter/1.9-14.2 mm wall*			
75 mm diameter/2.2-14.2 mm wall*			
90 mm diameter/2.5-14.2 mm wall*			
100 mm diameter/2.7-14.2 mm wall*			
115 mm diameter/3-14.2 mm wall*			
140 mm diameter/3.5-14.2 mm wall*			
165 mm diameter/ 3.9-14.2 mm wall*			
180 mm diameter/ 4.2-14.2 mm wall*			
200 mm diameter/ 4.6-14.2 mm wall*			
219 mm diameter/ 5.0-14.2 mm wall*			

* Typical pipe diameters shown, see below graph for intermediate sizes

Pipe diameter vs Wall thickness

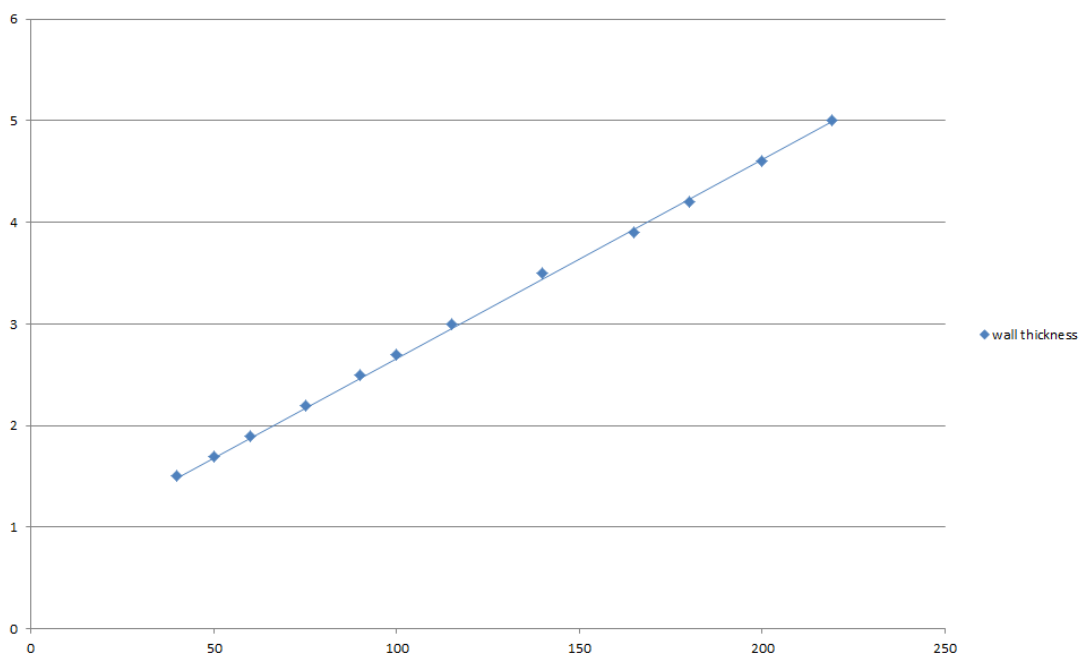

A.1.4 Single side penetration seal with metallic (and composite) pipes

Penetration Seal: LI (Local Interrupted) of minimum length stated below or CI (Continuous Interrupted) insulated metallic and composite pipes (single) fitted at any position within the aperture, with 25 mm deep K-FLEX K-FIRE ACRYLIC to either side of the wall (or at any position between), backed with 25 mm deep 40 kg/m³ stone wool insulation*.

Construction details:

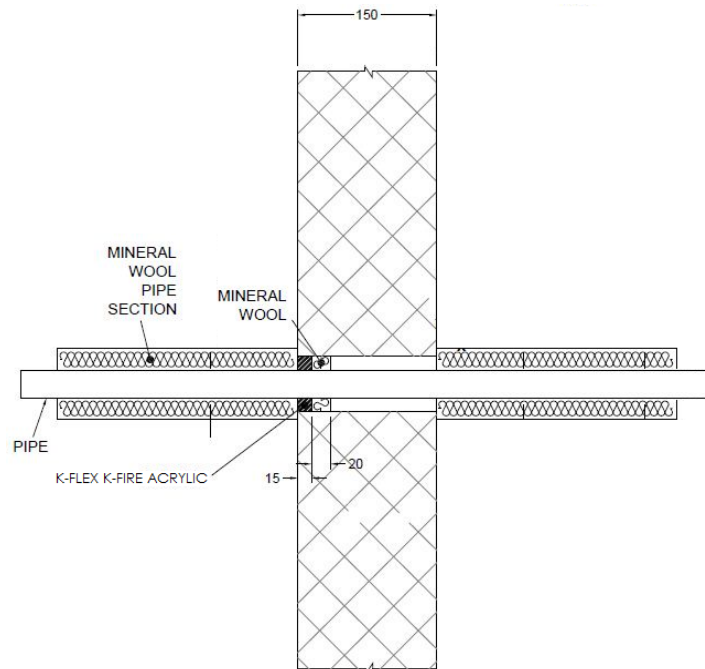

A.1.4.1

Services	Maximum Seal size	Insulation (minimum)	Classification
Copper pipe up to 54 mm diameter/0.9-14.2 mm wall	300 x 300 mm	1000 mm length 20 mm Stone wool insulation 80 kg/m ³	E 240 C/U, EI 60 C/U
Copper pipe up to 12 mm diameter/0.9-5 mm wall		25 mm AES Fibre ≥ 128kg/m ³ insulation, 600 mm long (min.)	
Alupex composite pipe 75 mm diameter/7.5 mm wall			

Services	Maximum seal size	Insulation (minimum)	Classification
Mild or stainless steel pipe	300 x 300 mm	1000 mm length of 20 mm Stone wool insulation 80 kg/m ³	E 240 C/U, EI 60 C/U
40 mm diameter/1.5-14.2 mm wall*			
40 mm diameter/1.5-14.2 mm wall*		1000 mm length of 30 mm Stone wool insulation 80 kg/m ³	
50 mm diameter/1.7-14.2 mm wall*			
60 mm diameter/1.9-14.2 mm wall*			
75 mm diameter/2.2-14.2 mm wall*			
90 mm diameter/2.5-14.2 mm wall*			
100 mm diameter/2.7-14.2 mm wall*			
115 mm diameter/3-14.2 mm wall*			
140 mm diameter/3.5-14.2 mm wall*			
165 mm diameter/ 3.9-14.2 mm wall*			
180 mm diameter/ 4.2-14.2 mm wall*			
200 mm diameter/ 4.6-14.2 mm wall*			
219 mm diameter/ 5.0-14.2 mm wall*			

* Typical pipe diameters shown, see below graph for intermediate sizes

Pipe diameter vs Wall thickness

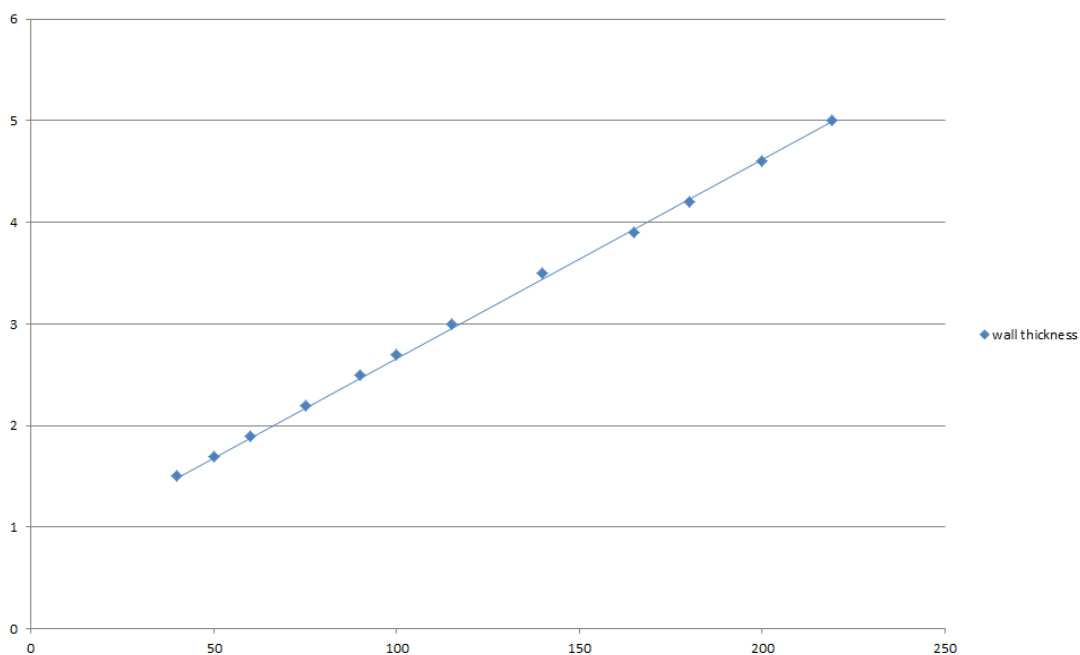

A.1.5 Single side penetration seal with metallic pipes

Penetration Seal: CS (Continuous Sustained) insulated metallic (single), with 25 mm deep K-FLEX K-FIRE ACRYLIC to either side of the wall (or at any position between), backed with 48 mm deep AES Fibre $\geq 128\text{kg/m}^3$ insulation. Minimum annular space 10 mm and minimum separation between penetrations seals of 30 mm. Maximum seal size 300 x 300 mm or 504 mm \varnothing .

Construction details:

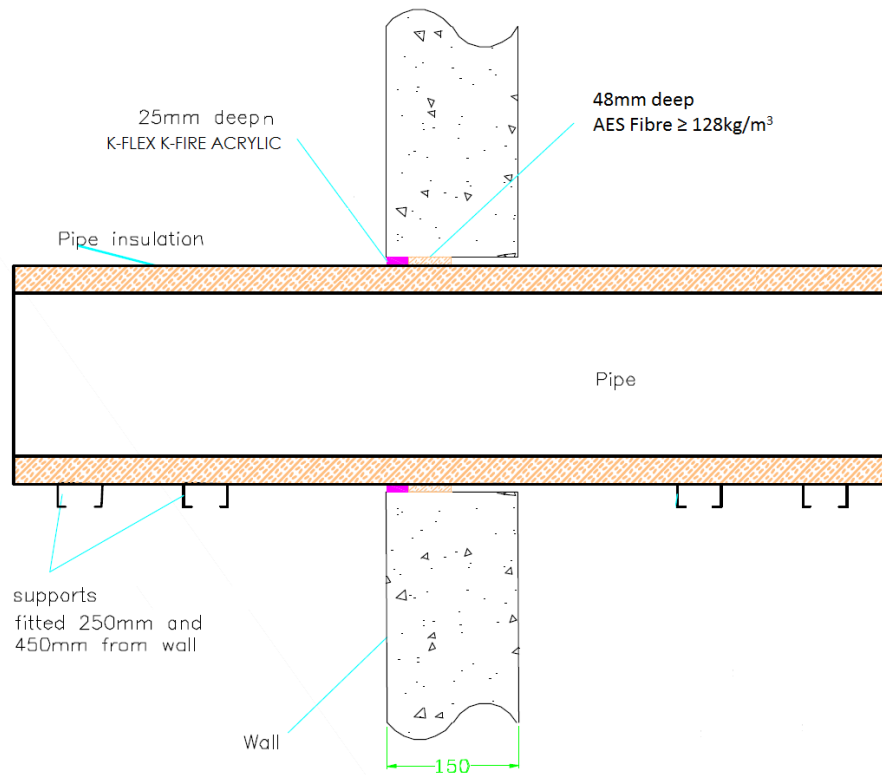

A.1.5.1 Single side penetration seal with pipes

Mild or stainless steel pipe	Insulation	Classification
40 mm diameter/1-14.2 mm wall	20 mm thick stone, mineral wool 80 kg/m ³	EI 240 C/U
40 mm diameter/1-14.2 mm wall*	30-80 mm thick stone, mineral wool min. 80 kg/m ³	EI 180 C/U
50 mm diameter/1.2-14.2 mm wall*		
60 mm diameter/1.4-14.2 mm wall*		
75 mm diameter/1.6-14.2 mm wall*		
90 mm diameter/1.9-14.2 mm wall*		
100 mm diameter/2.1-14.2 mm wall*		
115 mm diameter/2.4-14.2 mm wall*		
140 mm diameter/2.9-14.2 mm wall*		
165 mm diameter/ 3.4-14.2 mm wall*		
180 mm diameter/ 3.6-14.2 mm wall*		
200 mm diameter/ 4.0-14.2 mm wall*		
219 mm diameter/ 4.3-14.2 mm wall*		
250 mm diameter/ 5.0-14.2 mm wall*		
300 mm diameter/ 5.9-14.2 mm wall*		
324 mm diameter/ 6.35-14.2 mm wall*		

Pipe Diameter vs wall thickness

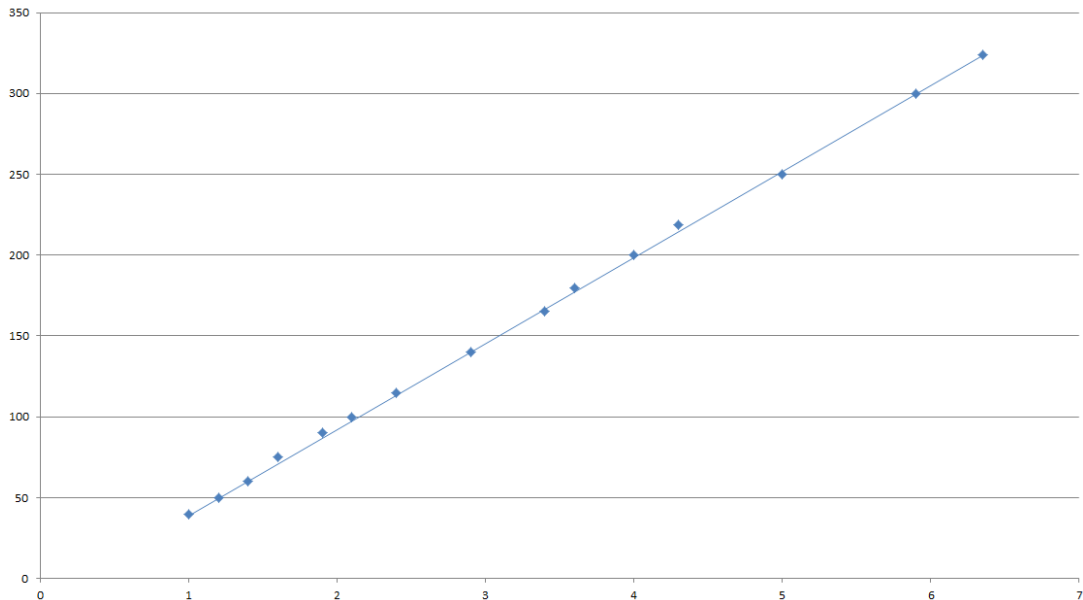

A.1.6 Double side penetration seal with metallic pipes

Penetration Seal: 1000 mm (min.) LI (Local Interrupted) or CI (Continuous Interrupted) insulated metallic pipes (single) fitted at any position within the aperture, with 15 mm deep K-FLEX K-FIRE ACRYLIC to both sides of the), backed with 20 or 30 mm deep 40 kg/m³ stone wool insulation.

Construction details:

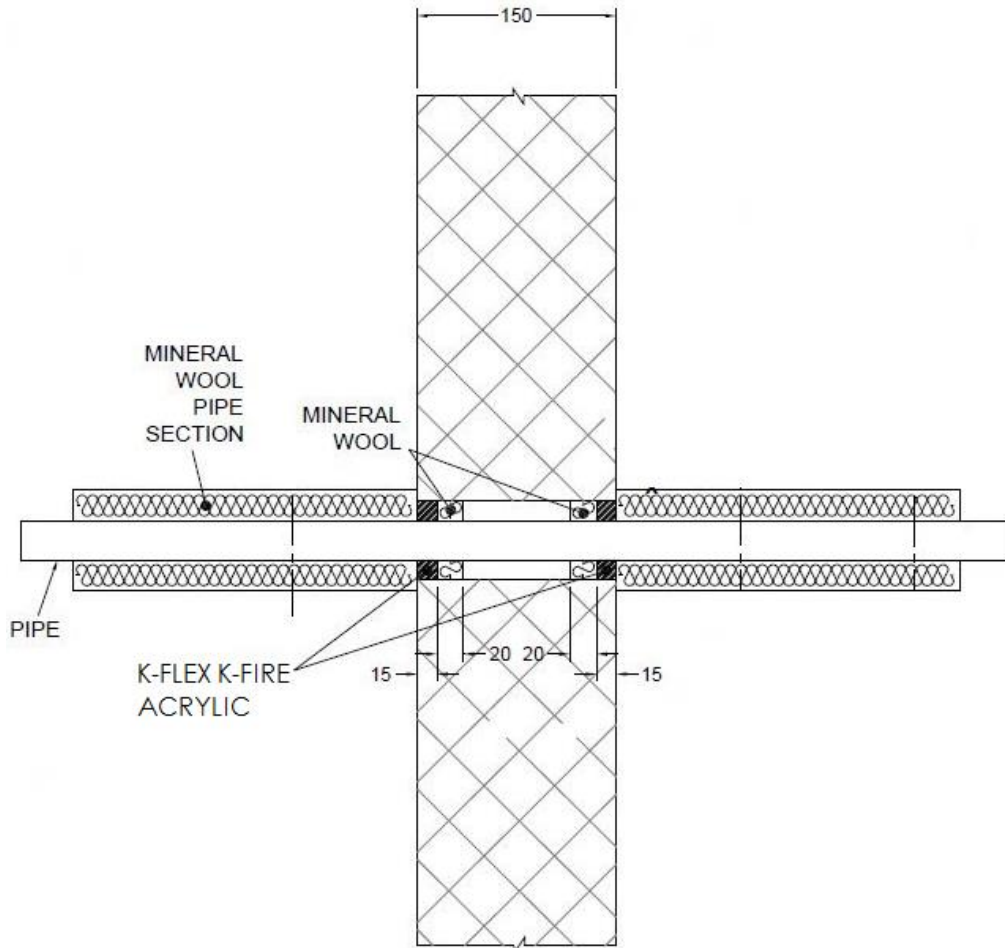

A.1.6.1

Services	Maximum seal size	Insulation (minimum)	Classification
Mild or stainless steel pipe			
40 mm diameter/1.5-14.2 mm wall*	300 x 300 mm	20 mm Stone wool insulation 80 kg/m ³	EI 240 C/U
40 mm diameter/1.5-14.2 mm wall*		30 mm Stone wool insulation 80 kg/m ³	E 240, EI 120 C/U
50 mm diameter/1.7-14.2 mm wall*			
60 mm diameter/1.9-14.2 mm wall*			
75 mm diameter/2.2-14.2 mm wall*			
90 mm diameter/2.5-14.2 mm wall*			
100 mm diameter/2.7-14.2 mm wall*			
115 mm diameter/3-14.2 mm wall*			
140 mm diameter/3.5-14.2 mm wall*			
165 mm diameter/ 3.9-14.2 mm wall*			
180 mm diameter/ 4.2-14.2 mm wall*			
200 mm diameter/ 4.6-14.2 mm wall*			
219 mm diameter/ 5.0-14.2 mm wall*			

* Typical pipe diameters shown, see below graph for intermediate sizes

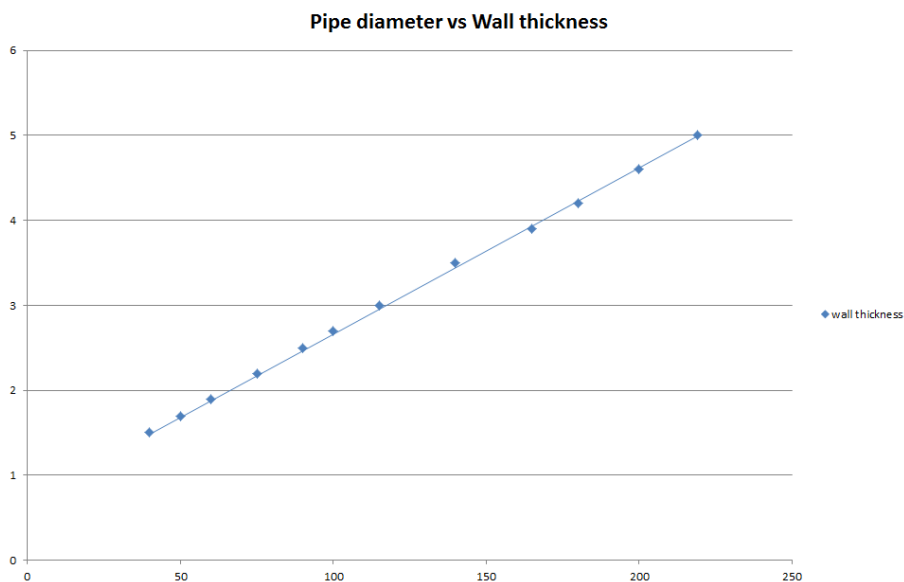

A.1.7 Double side penetration seal with metallic pipes

Penetration Seal: CS (Continuous Sustained) insulated metallic pipes (single) fitted at any position within the aperture, with 15 mm K-FLEX K-FIRE ACRYLIC to both sides of the wall, backed with 25 mm deep stone wool insulation 35 kg/m³. Minimum annular space 10 mm (A1) and minimum separation between penetration seals 30 mm (A2). Maximum seal size 300 x 300 mm / 504 mm Ø

Construction details:

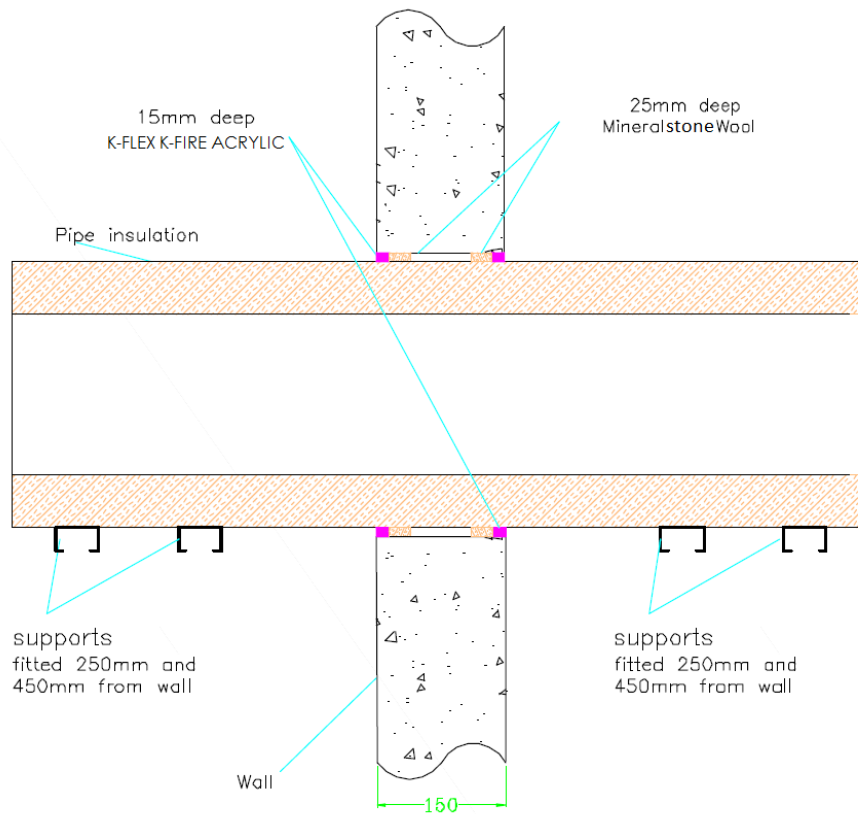

Configuration 1

Option 1

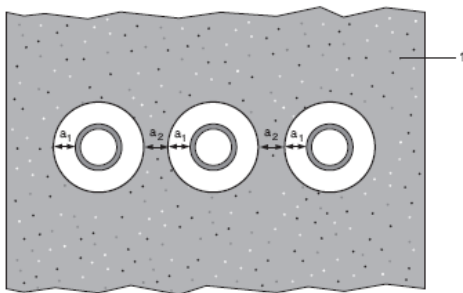

Configuration 2

Option 2

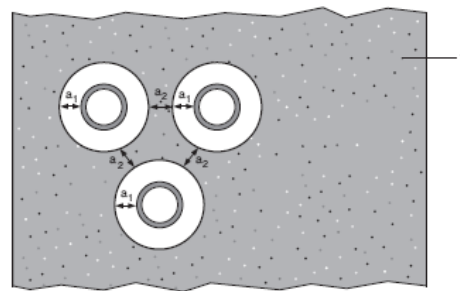

Key

1 Supporting construction

a1 Pipe / top edge of seal separation

a2 Pipe / side edge of seal separation

a3 Pipe / pipe separation

A.1.7.1 Double side penetration seal with pipes

Mild or stainless steel pipe	Insulation	Classification
40 mm diameter/1-14.2 mm wall	20 mm thick stone, mineral wool min. 80 kg/m ³	EI 240 C/U
40 mm diameter/1-14.2 mm wall*	30-80 mm thick stone, mineral wool min. 80 kg/m ³	
50 mm diameter/1.2-14.2 mm wall*		
60 mm diameter/1.4-14.2 mm wall*		
75 mm diameter/1.6-14.2 mm wall*		
90 mm diameter/1.9-14.2 mm wall*		
100 mm diameter/2.1-14.2 mm wall*		
115 mm diameter/2.4-14.2 mm wall*		
140 mm diameter/2.9-14.2 mm wall*		
165 mm diameter/ 3.4-14.2 mm wall*		
180 mm diameter/ 3.6-14.2 mm wall*		
200 mm diameter/ 4.0-14.2 mm wall*		
219 mm diameter/ 4.3-14.2 mm wall*		
250 mm diameter/ 5.0-14.2 mm wall*		
300 mm diameter/ 5.9-14.2 mm wall*		
324 mm diameter/ 6.35-14.2 mm wall*		

Pipe Diameter vs wall thickness

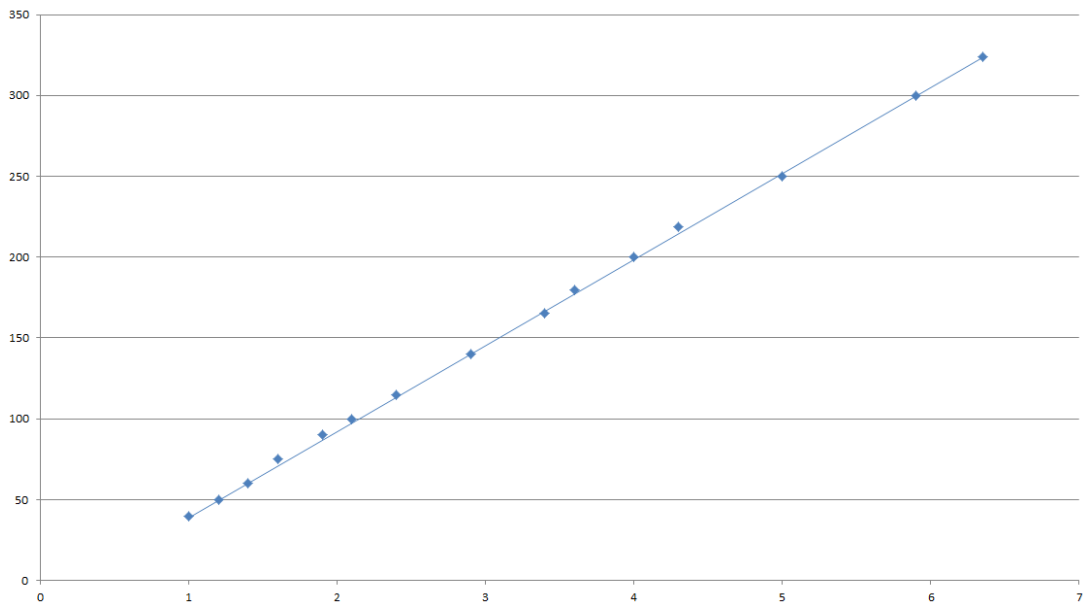

A.1.8 Double side penetration seal with metallic pipes with combustible insulation

Penetration Seal: CS (Continuous Sustained) insulated metallic pipes (single) fitted at any position within the aperture, with 25 mm K-FLEX K-FIRE ACRYLIC to both sides of the wall, backed with 25 mm deep stone wool insulation 35 kg/m³. Minimum annular space 10 mm (A1) and minimum separation between penetration seals 30 mm (A2). Maximum seal size 300 x 300 mm / 300 mm Ø

Construction details:

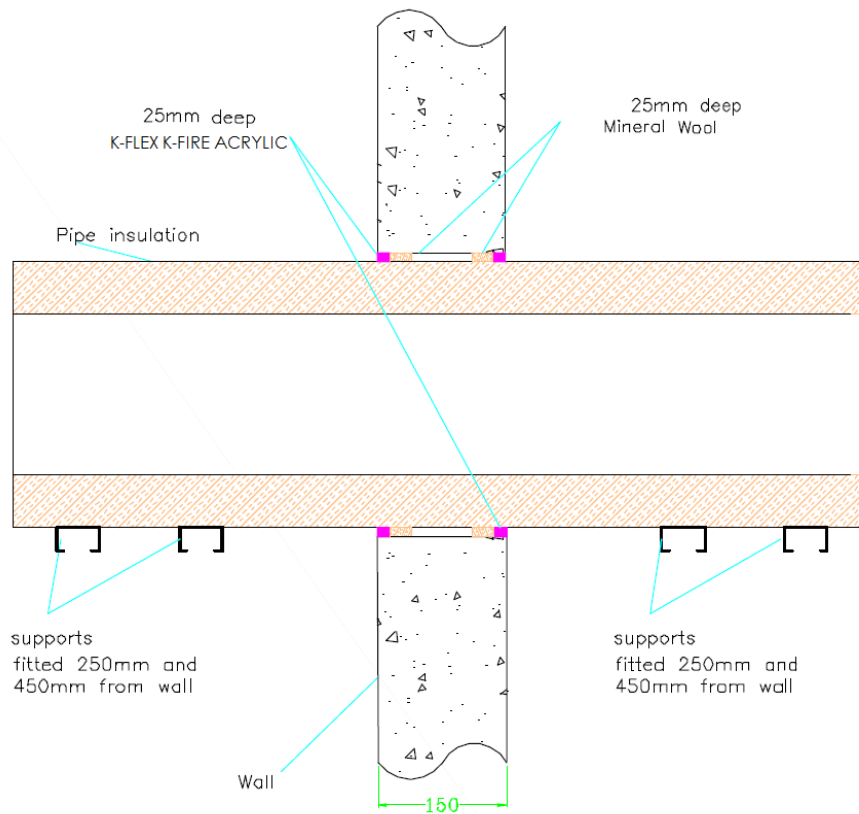

Configuration 1

Option 1

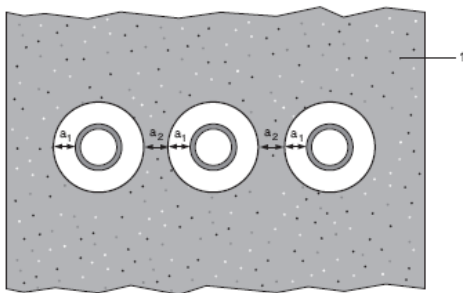

Configuration 2

Option 2

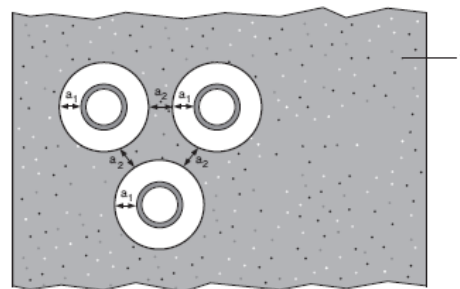

Key

1 Supporting construction

a1 Pipe / top edge of seal separation

a2 Pipe / side edge of seal separation

a3 Pipe / pipe separation

A.1.8.1 Double side penetration seal with metallic pipes with combustible insulation

Mild or stainless steel pipe	Insulation	Classification
22 mm diameter/2-11 mm wall	13 mm thick Elastomeric insulation minimum class B-s3,d0	E 240 C/U, EI 180 C/U
22-114 mm diameter/2-14.2 mm wall	13-25 mm thick Elastomeric insulation minimum class B-s3,d0	E 120 C/U, EI 90 C/U
22-114 mm diameter/2-14.2 mm wall	25-50 mm thick Elastomeric insulation minimum class B-s3,d0	EI 60 C/U

A.1.9 Double side penetration seal with plastic pipes

Penetration Seal: Plastic pipes (single) fitted at any position within the aperture, with 25 mm K-FLEX K-FIRE ACRYLIC to both sides of the wall, backed with 25 mm deep stone wool insulation 35 kg/m³. Minimum annular space 10 mm (A1) and minimum separation between penetration seals 30 mm (A2). Maximum seal size 300 x 300 mm / 300 mm Ø

Construction details:

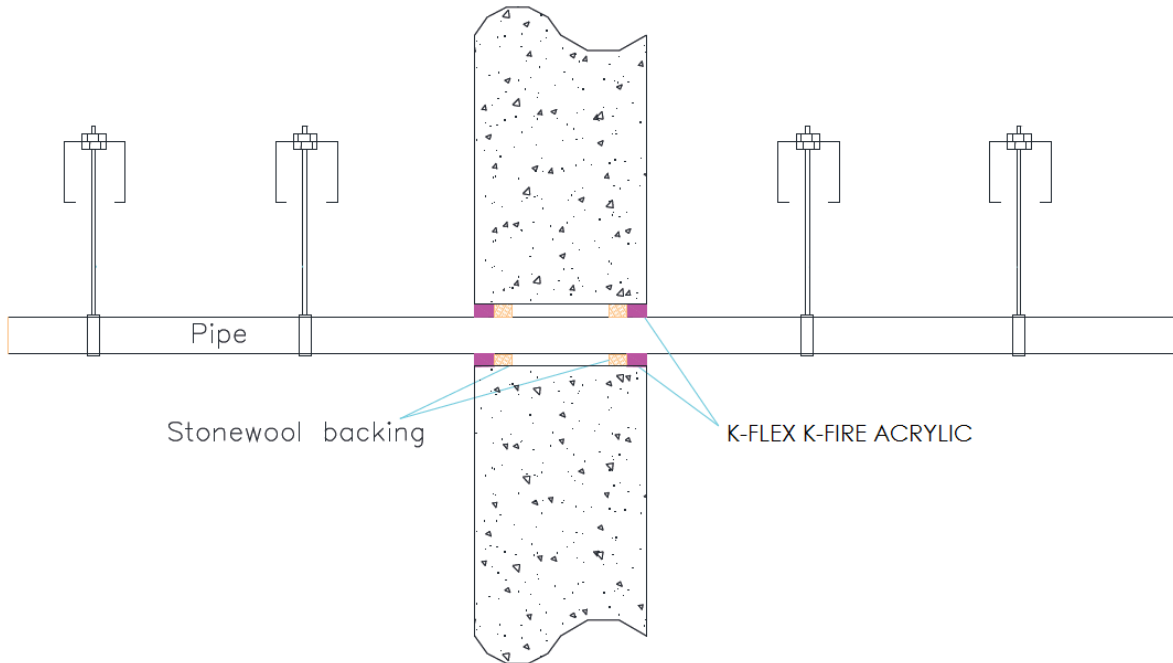

Configuration 1

Option 1

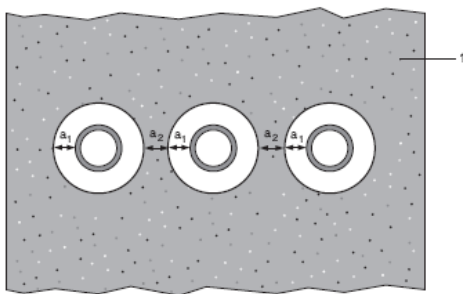

Configuration 2

Option 2

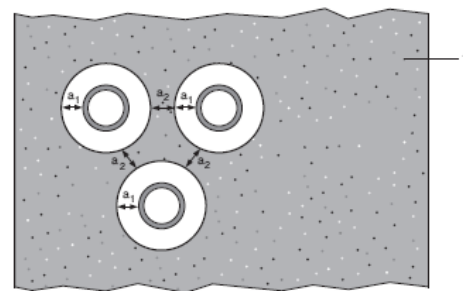

Key

1 Supporting construction

a1 Pipe / top edge of seal separation

a2 Pipe / side edge of seal separation

A.1.9.1 Double side penetration seal with plastic pipes

Pipe material	Size	Classification
PVC-U pipe according to EN 1329-1, EN 1452-1 and EN 1453-1, PVC-C according to EN 1566-1	32 mm diameter/1.6 mm wall	EI 240 U/C
PP pipe according to EN 1451-1	32 mm diameter/2.0-4.4 mm wall	EI 180 C/U
PE pipe according to EN 1519-1, EN 12201-2 and EN 12666-1, ABS according to EN 1455-1 and pipes made from SAN+PVC according to EN 1565-1	20-32 mm diameter/2.0 mm wall	EI 240 C/U

A.2 Flexible wall constructions according to 2. 2) with wall thickness of minimum 75 mm

A.2.1 Double side penetration seal with cables

Penetration Seal: Cables (single or bundles up to 100 mm \varnothing) and pipes fitted at any position within the aperture, with K-FLEX K-FIRE ACRYLIC to both sides of the wall. Minimum annular space 10 mm (A1) and minimum separation between penetration seals 30 mm (A2), maximum seal size 150 x 150 mm / 344 mm diameter (when incorporating a pipe of seal diameter -20 mm).

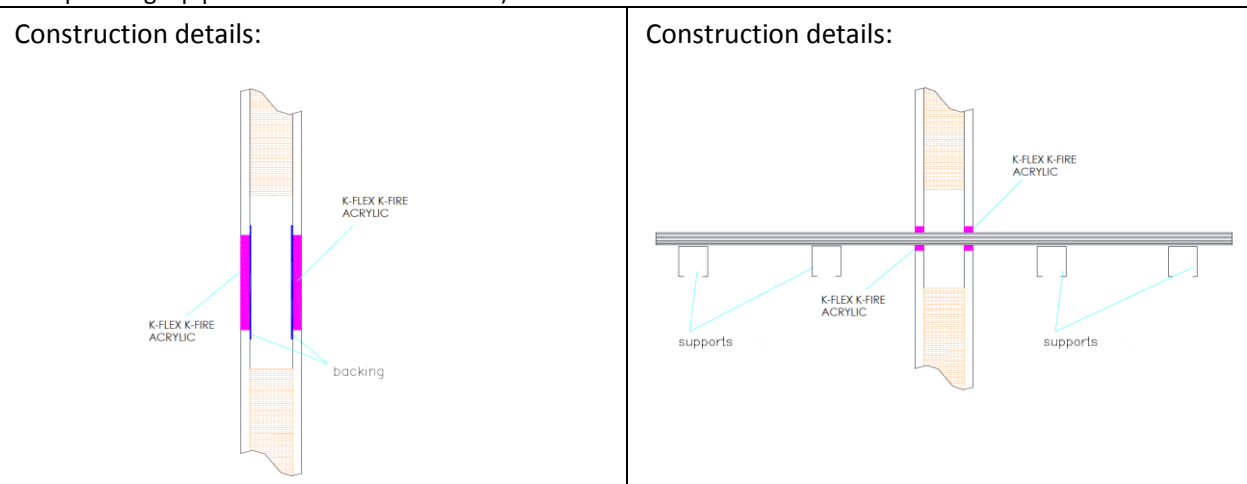

A.2.1.1

Services	Sealant depth	Backing	Classification
None (blank)	12.5 mm	Any material	EI 60
Cables up to 21 mm \varnothing , single		None	E 60, EI 45
Cables up to 21 mm \varnothing , in bundles up to 100 mm \varnothing			E 45, EI 30
Mild or stainless steel pipe			
4 mm diameter / 0.7-2.0 mm wall	12.5 mm	None	E 60 C/U, EI 45 C/U
5-22 mm diameter / 0.7-11 mm wall*			E 60 C/U, EI 30 C/U
Mild or stainless steel pipe with 80 kg/m³ density stone wool insulation Continuous Sustained (CS)			
40 mm diameter / 1-14.2 mm wall, 20 mm insulation	12.5 mm	None	E 60 C/U, EI 45 C/U
40-324 mm diameter / 1.0-14.2 mm wall, 30 mm insulation*			
PVC-U pipe according to EN 1329-1, EN 1452-1 and EN 1453-1, PVC-C according to EN 1566-1			
6-32 mm \varnothing / 1.0-1.8 mm wall, with bundle of cables up to 21 mm diameter*	12.5 mm	None	E 60 U/C, EI 45 U/C
PP pipe according to EN 1451-1			
20 mm \varnothing / 2.3 mm wall	12.5 mm	None	EI 45 U/C
21-32 mm \varnothing / 2.3-4.4 mm wall*			EI 30 U/C
21-32 mm \varnothing / 2.3-4.4 mm wall, with bundle of cables up to 21 mm diameter*			E 45 U/C, EI 30 U/C
PE pipe according to EN 1519-1, EN 12201-2 and EN 12666-1, ABS according to EN 1455-1 and pipes made from SAN+PVC according to EN 1565-1			
20 mm \varnothing / 2.0 mm wall	12.5 mm	None	EI 45 U/C
21-32 mm \varnothing / 2.0-3.0 mm wall*			EI 30 U/C
21-32 mm \varnothing / 2.0-3.0 mm wall, with bundle of cables up to 21 mm* diameter			E 45 U/C, EI 30 U/C

* See below graphs for interpolated pipe sizes

Steel Pipe- E 60 U/C, EI 30 U/C

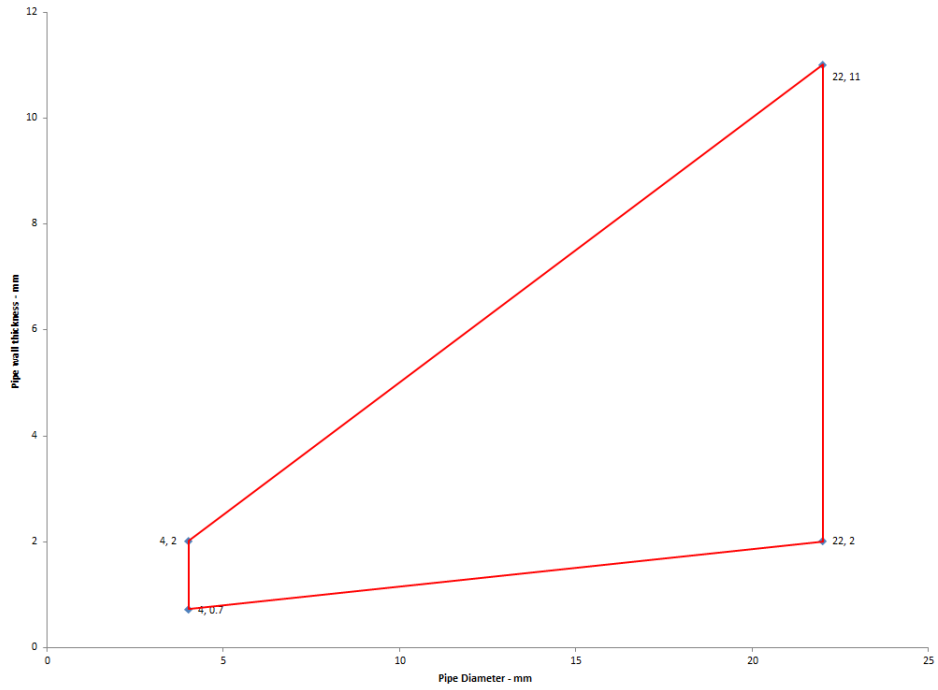

Steel pipes with 30 mm Insulation

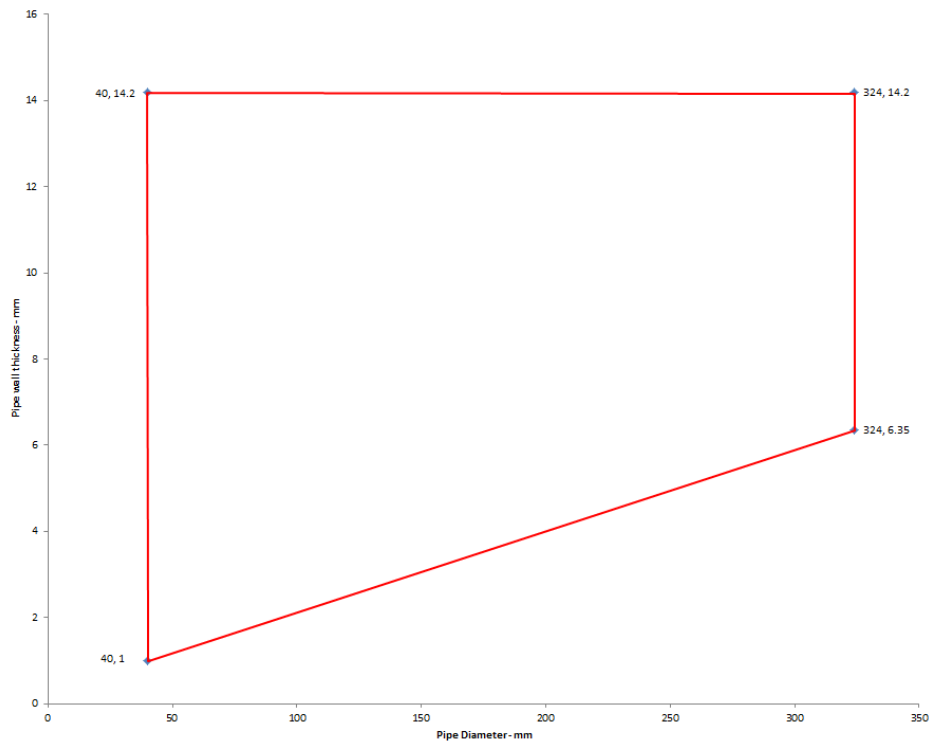

PP pipes - EI 30 U/C

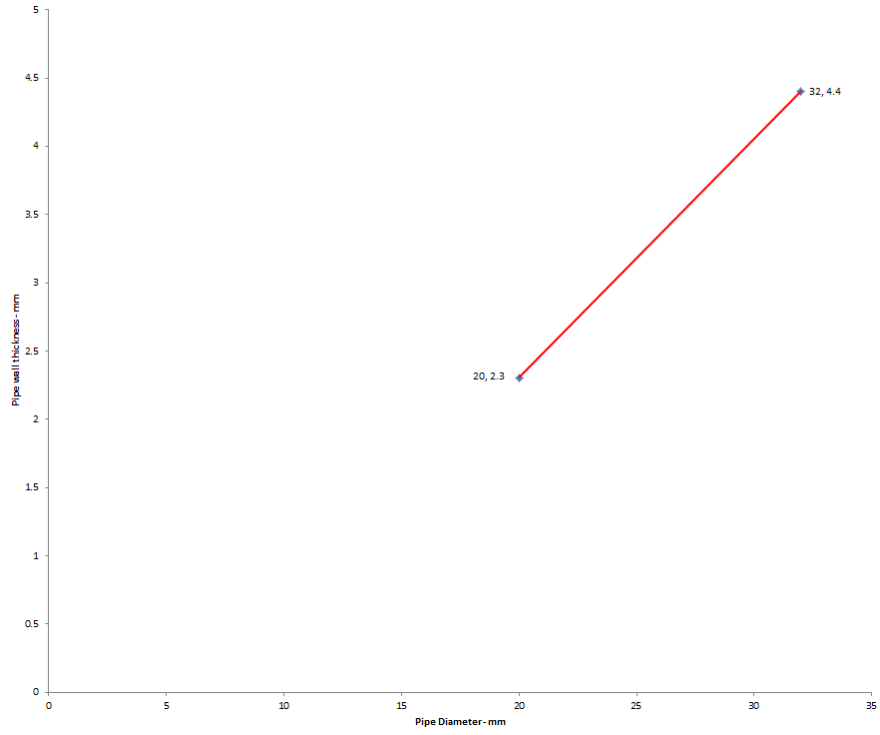

PE pipes - EI 30 U/C

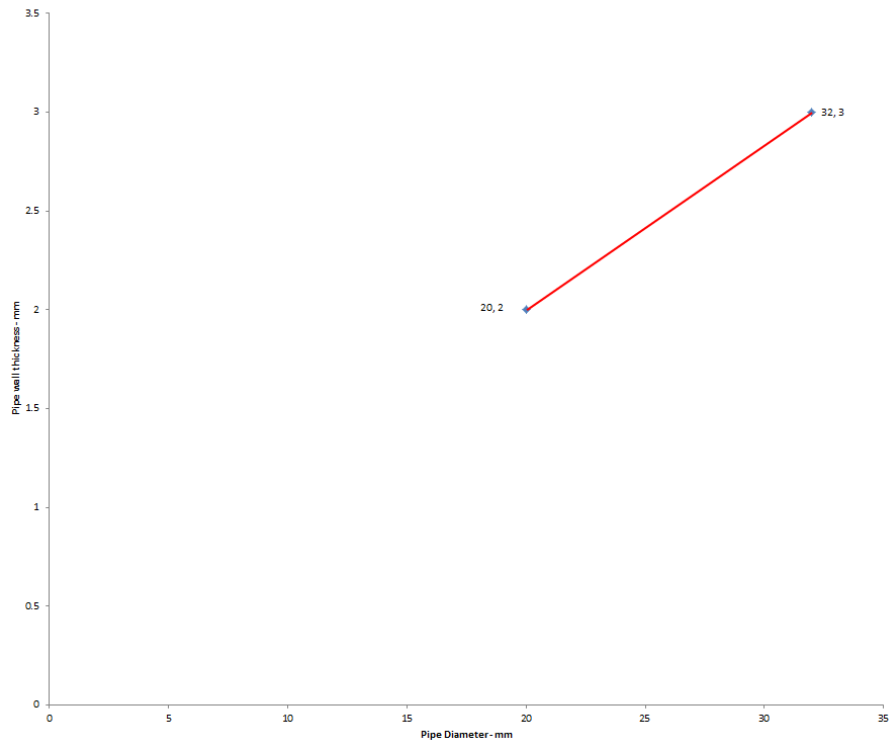

PVC-U pipes U/C

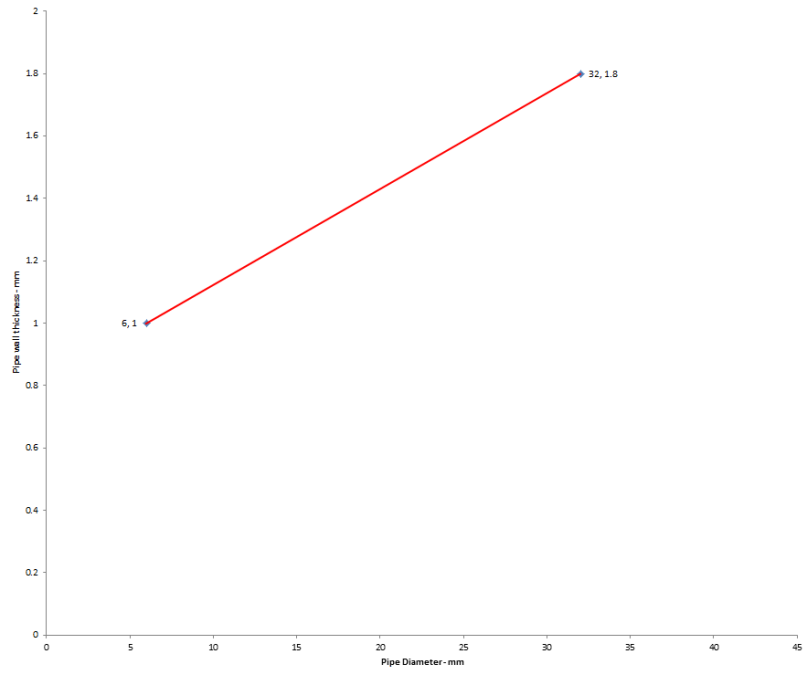

A.3 Flexible wall constructions according to 2. 2) with wall thickness of minimum 100 mm

A.3.1 Double side penetration seal with cables

Penetration Seal: Cables (single or bundles up to 100 mm \varnothing) fitted at any position within the aperture, with K-FLEX K-FIRE ACRYLIC to both sides of the wall, backed with stone wool insulation 40kg/m³, 140 kg/m³ or 'AES Fibre \geq 128kg/m³'.

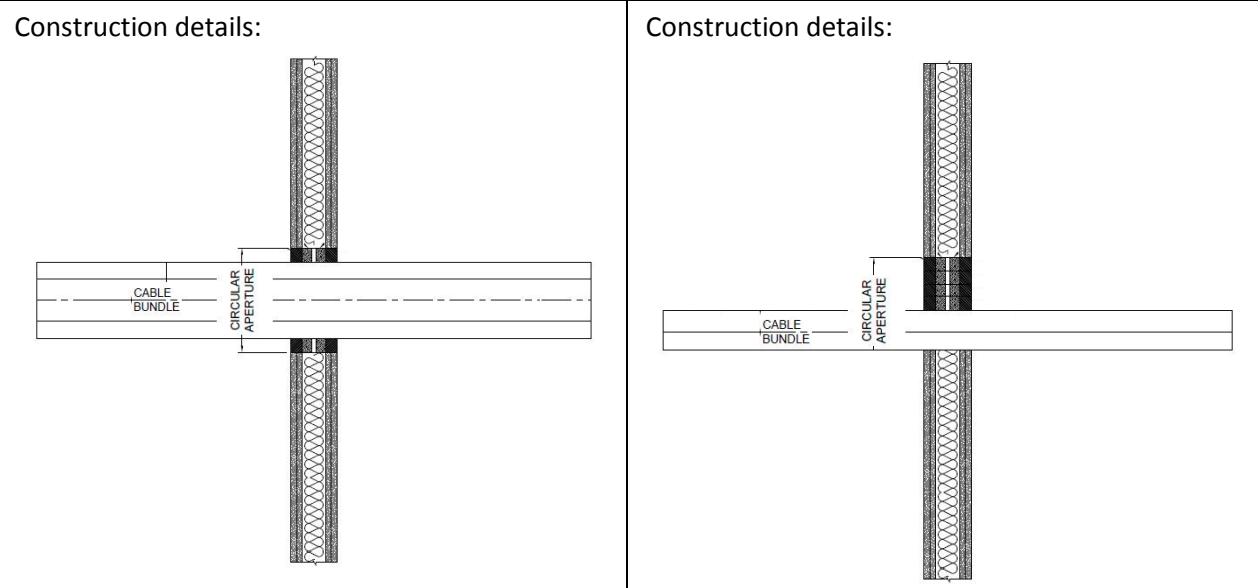

A.3.1.1

Services	Sealant depth	Backing	Maximum aperture	Classification
None (blank)	12.5 mm	Stone wool 20 mm deep 35-140 kg/m ³	300 x 300 mm*	EI 120
Electrical cables up to 21 mm \varnothing , single or in bundles up to 100 mm \varnothing	25 mm	Stone wool 20 mm deep 40 kg/m ³		EI 120
Electrical cables up to 80 mm \varnothing , single or in bundles up to 100 mm \varnothing		25 mm AES Fibre \geq 128kg/m ³		E 120, EI 60
Cables up to 21 mm \varnothing single or in bundles up to 100 mm \varnothing		Stone wool 20 mm deep 40 kg/m ³		EI120
Single 'E cable' - 1 x 185 mm ² core HD603.3 electrical cable with PVC insulation, PVC sheath and 23-27 mm diameter	12.5 mm	Stone wool 20 mm deep/140 kg/m ³		E 120, EI 60

* Or 30 mm wide x 3000 mm high for cables up to 21 mm \varnothing

A.3.2 Double side penetration seal with metallic pipes

Penetration Seal: CS (Continuous Sustained) insulated metallic pipes (single) fitted at any position within the aperture, with K-FLEX K-FIRE ACRYLIC to both sides of the wall, backed with stone wool insulation or 'AES Fibre $\geq 128\text{kg/m}^3$ ', 300 x 300 mm maximum seal size.

Construction details:

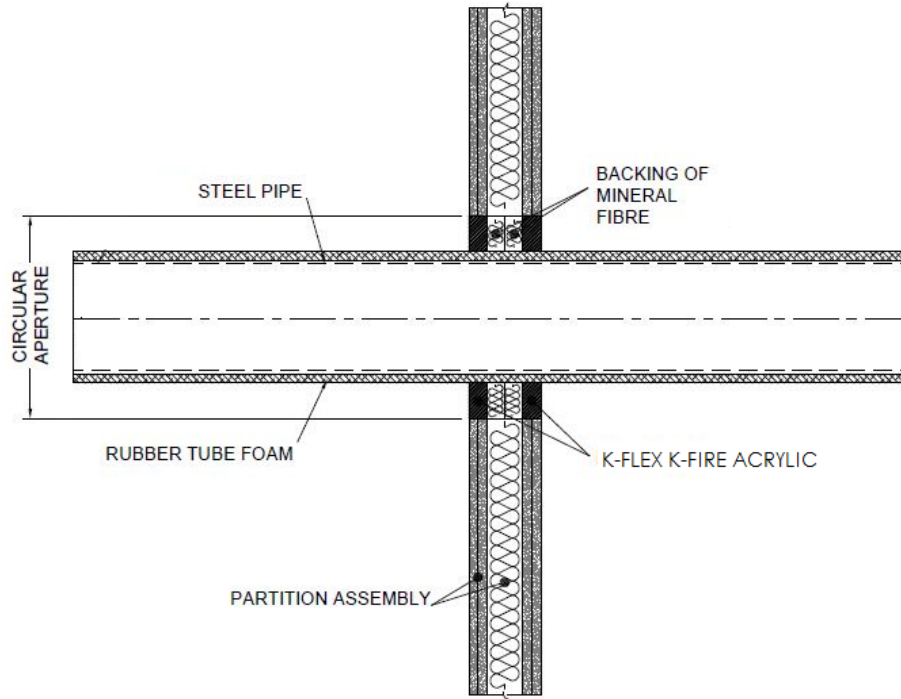

A.3.2.1

Services	Sealant depth	Backing	Insulation	Classification
Mild or stainless steel pipe				
22 mm diameter/3-10 mm wall	25 mm	Stone wool 25 mm deep 35 kg/m ³	None	EI 120 C/C
40 mm diameter/1-14.2 mm wall	12.5 mm	20 mm Stone wool 40 kg/m ³	13 -19 mm Elastomeric insulation minimum class B-s3,d0	EI 120 C/C
40 mm diameter/1-14.2 mm wall*	25 mm	25 mm AES Fibre ≥ 128kg/m ³		E 120 C/C EI 60 C/C
50 mm diameter/1.3-14.2 mm wall*				
60 mm diameter/1.6-14.2 mm wall*				
75 mm diameter/2-14.2 mm wall*				
90 mm diameter/2.4-14.2 mm wall*				
100 mm diameter/2.7-14.2 mm wall*				
115 mm diameter/3.1-14.2 mm wall*				
140 mm diameter/3.8-14.2 mm wall*				
165 mm diameter/ 4.5-14.2 mm wall*				

* Typical pipe diameters shown, see below graph for intermediate sizes

Pipe diameter vs Wall thickness

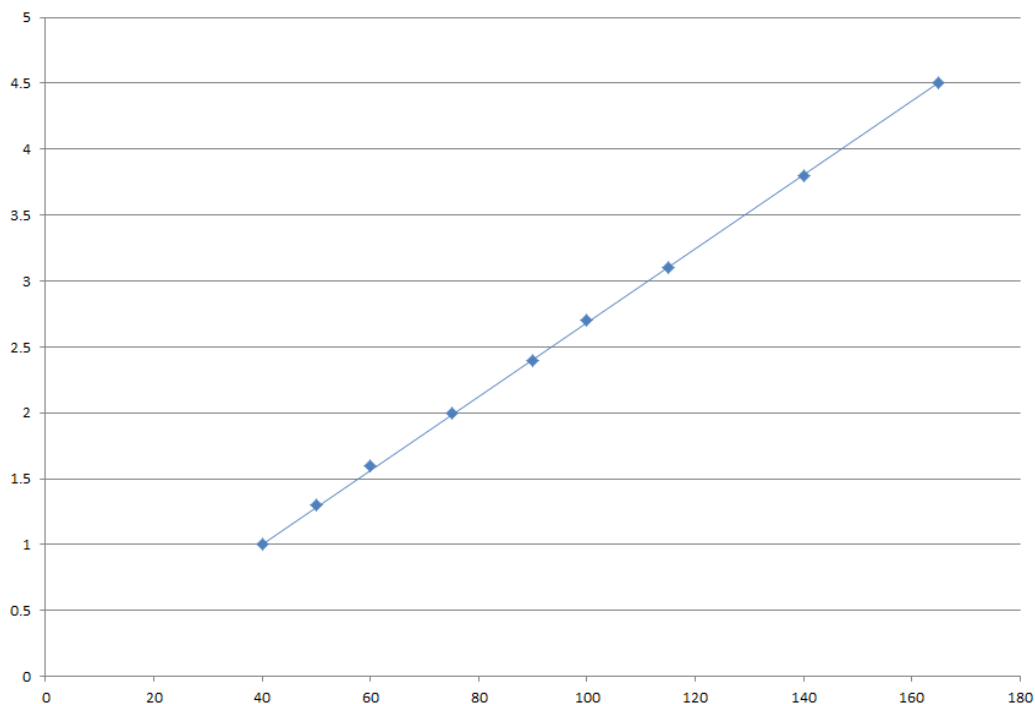

Services	Sealant depth	Backing	Insulation	Classification
Copper pipe				
12 mm diameter/1 mm wall	25 mm	25 mm AES Fibre \geq 128kg/m ³	9 mm Elastomeric insulation minimum class B-s3,d0	EI 120 C/C
12-54 mm diameter/1-1.2 mm wall			9-13 mm Elastomeric insulation minimum class B-s3,d0	E 120, EI 60 C/C
12-54 mm diameter/1-1.2 mm wall			13-25 mm Elastomeric insulation minimum class B-s3,d0	EI 60 C/C
Alupex Composite Pipe				
16 mm diameter/2.25 mm wall	25 mm	25 mm AES Fibre \geq 128kg/m ³	9 mm Elastomeric insulation minimum class B-s3,d0	EI 120 C/C
16 mm diameter/2.25 mm wall			9-25 mm Elastomeric insulation minimum class B-s3,d0	EI 60 C/C
20 mm diameter/2.5 mm wall				
26 mm diameter/3 mm wall				
32 mm diameter/3 mm wall				
40 mm diameter/3.5 mm wall				
50 mm diameter/4 mm wall				
63 mm diameter/4.5 mm wall				
75 mm diameter/4.7 mm wall				

A.3.3 Double side penetration seal with metallic pipes

Penetration Seal: CS (Continuous Sustained) insulated metallic pipes (single) fitted at any position within the aperture, with 12.5 mm K-FLEX K-FIRE ACRYLIC to both sides of the wall, backed with 12.5 mm deep stone wool insulation 35 kg/m³. Minimum annular space 10 mm (A1) and minimum separation between penetration seals 30 mm (A2). Maximum seal size 300 x 300 mm / 504 mm Ø

Construction details:

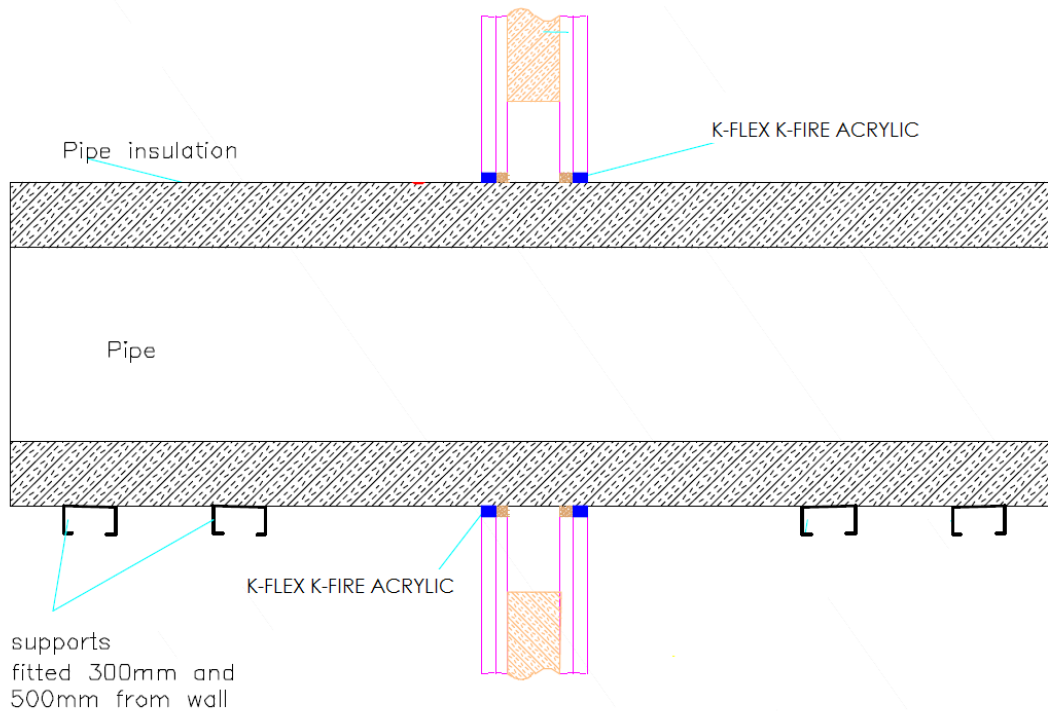

Configuration 1

Option 1

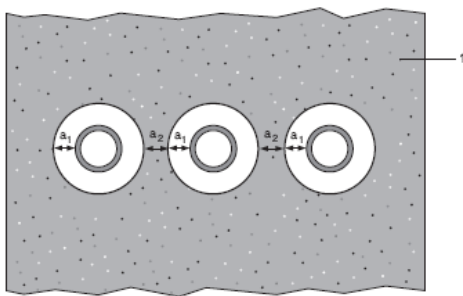

Configuration 2

Option 2

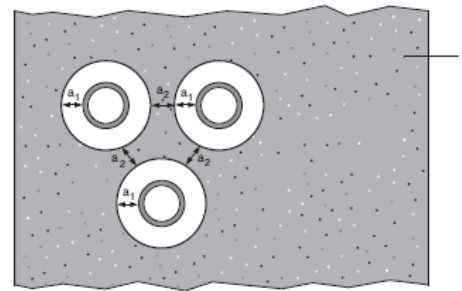

Key

1 Supporting construction

a1 Pipe / top edge of seal separation

a2 Pipe / side edge of seal separation

a3 Pipe / pipe separation

A.3.3.1 Double side penetration seal with pipes

Mild or stainless steel pipe	Insulation	Classification
40 mm diameter/1-14.2 mm wall	20 mm thick stone, mineral wool min. 80 kg/m ³	E 120 C/U EI 90 C/U
40 mm diameter/1-14.2 mm wall*	30-80 mm thick stone, mineral wool min. 80 kg/m ³	
50 mm diameter/1.2-14.2 mm wall*		
60 mm diameter/1.4-14.2 mm wall*		
75 mm diameter/1.6-14.2 mm wall*		
90 mm diameter/1.9-14.2 mm wall*		
100 mm diameter/2.1-14.2 mm wall*		
115 mm diameter/2.4-14.2 mm wall*		
140 mm diameter/2.9-14.2 mm wall*		
165 mm diameter/ 3.4-14.2 mm wall*		
180 mm diameter/ 3.6-14.2 mm wall*		
200 mm diameter/ 4.0-14.2 mm wall*		
219 mm diameter/ 4.3-14.2 mm wall*		
250 mm diameter/ 5.0-14.2 mm wall*		
300 mm diameter/ 5.9-14.2 mm wall*		
324 mm diameter/ 6.35-14.2 mm wall*		

Pipe Diameter vs wall thickness

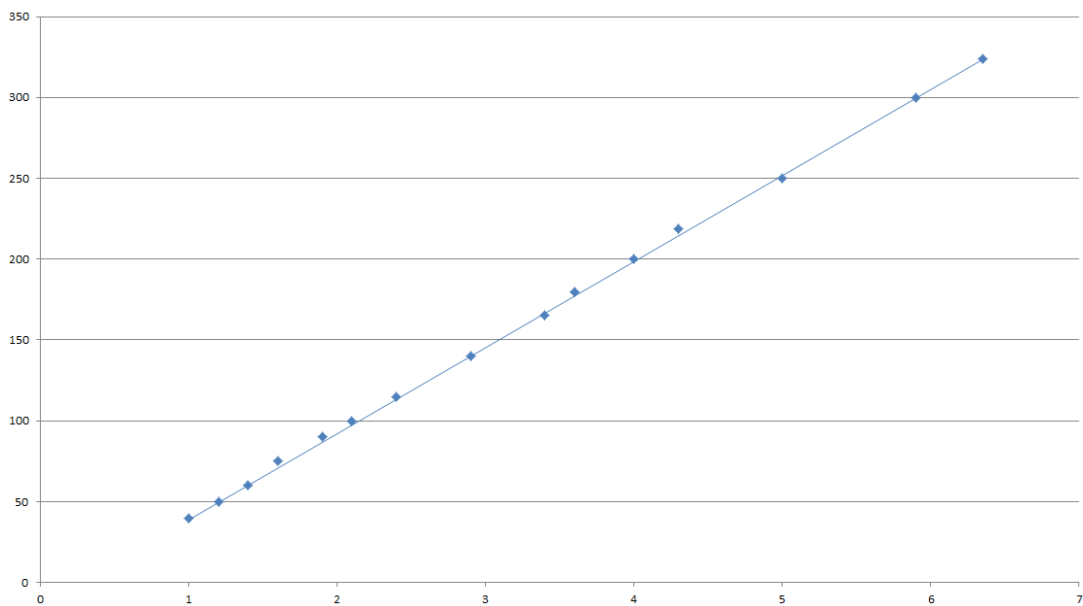

PEX pipe in pipe system	Insulation	Classification
15 mm diameter x 2.5 mm wall inner /25mm diameter outer	None	EI 120 C/C
Alupex pipe	Insulation	Classification
16-20 mm diameter/2.0 mm wall	None	EI 120 C/C
Mild or Stainless Steel pipe	Insulation	Classification
4 mm diameter/1.0-2.0 mm wall	None	EI 90 C/C
5-30 mm diameter/1.0-14.2 mm wall*		EI 120 C/U
30 mm diameter/2.0-14.2 mm wall		
Copper or Steel pipe	Insulation	Classification
6 mm diameter/0.7-3.0 mm wall	None	E 90 C/C, EI 60 C/C
7-22 mm diameter/0.7-11 mm wall		E 90 C/C, EI 30 C/C

* See below graphs for interpolated pipe sizes

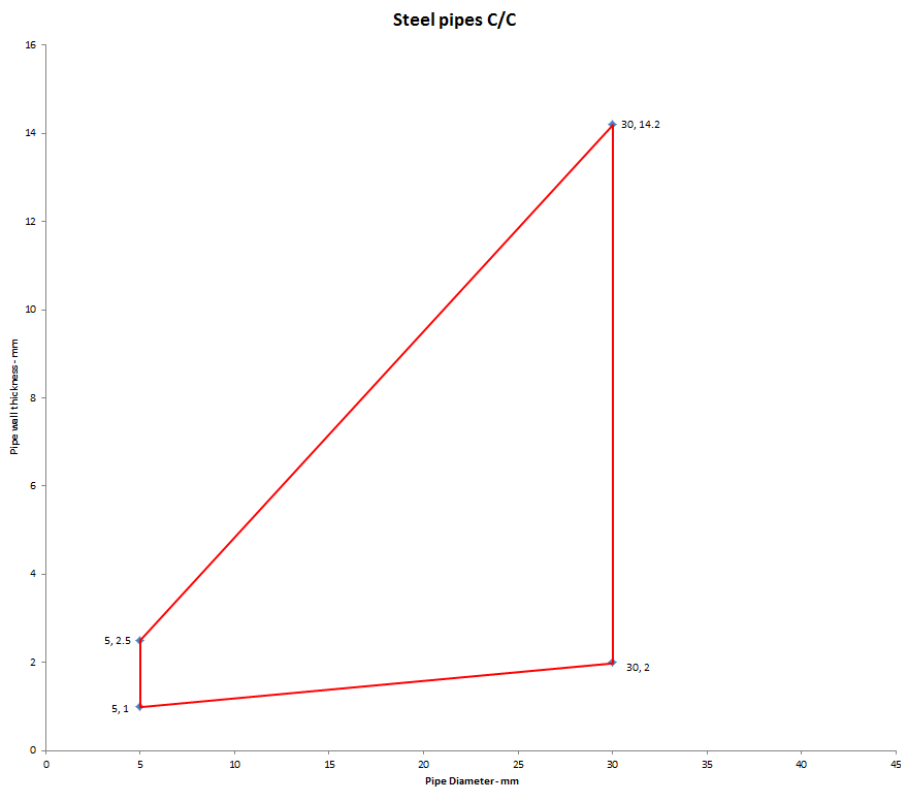

Copper pipes C/C

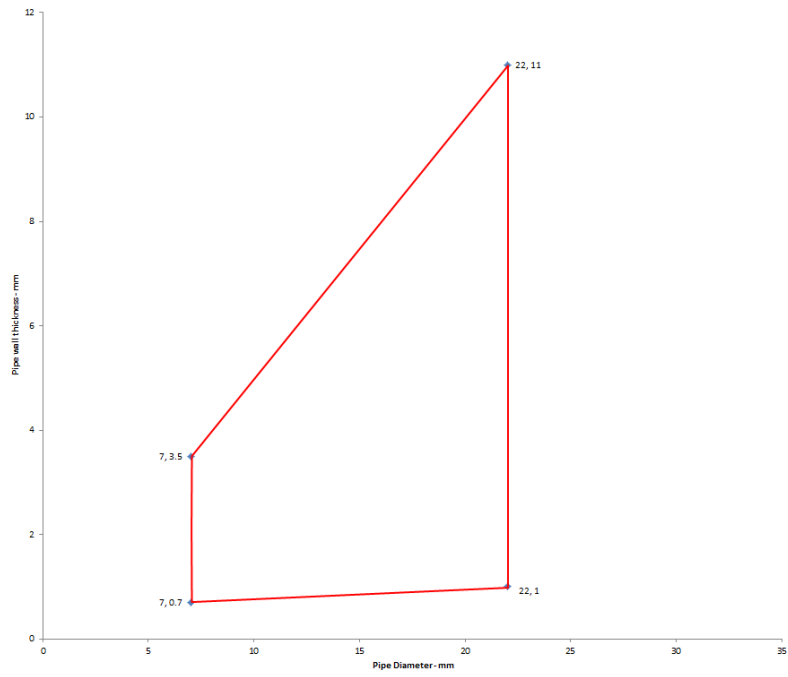

A.3.4 Double side penetration seal with composite pipes

Penetration Seal: CI (Continuous Interrupted) or CS (Continuous Sustained) insulated composite pipes (single) fitted at any position within the aperture, with K-FLEX K-FIRE ACRYLIC to both sides of the wall, minimum 10 mm seal width around service, maximum seal size 300 x 300 mm, backed with stonewool.

Construction details:

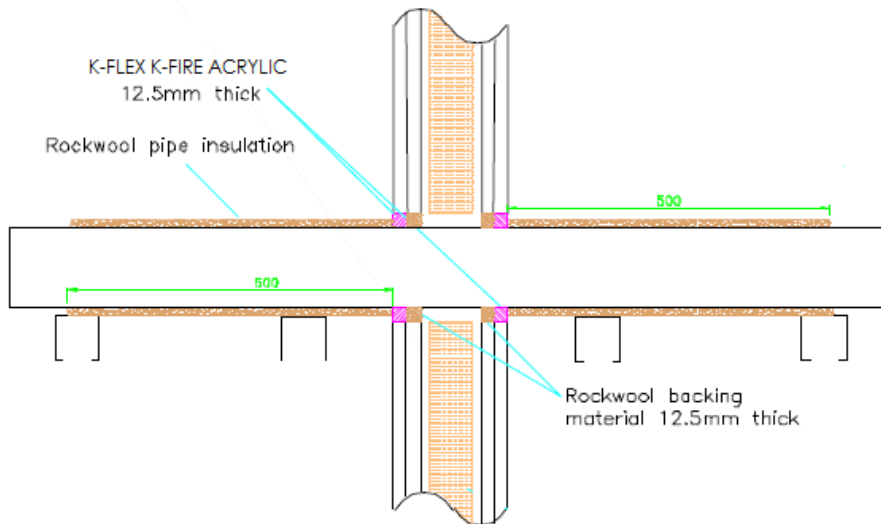

A.3.4.1

Services	Sealant depth	Backing	Insulation (minimums)	Classification
Alupex Composite Pipe	12.5 mm	12.5 mm stonewool 40 kg/m ³	20 mm stonewool 80 kg/m ³ , 500 mm length from both sides of the seal	EI 120 C/C
16 mm diameter/2.25 mm wall				
20 mm diameter/2.5 mm wall				
26 mm diameter/3 mm wall				
32 mm diameter/3 mm wall				
40 mm diameter/3.5 mm wall				
50 mm diameter/4 mm wall				
63 mm diameter/4.5 mm wall				
75 mm diameter/4.7 mm wall				

A.3.5 Double side penetration seal with metallic (and composite) pipes

Penetration Seal: LI (Local Interrupted) of minimum length stated below or CI (Continuous Interrupted) insulated metallic pipes and composite (single) fitted at any position within the aperture, with K-FLEX K-FIRE ACRYLIC to both sides of the wall, min. 10 mm seal width around service, backed with stone wool insulation or 'AES Fibre $\geq 128\text{kg/m}^3$ '.

Construction details:

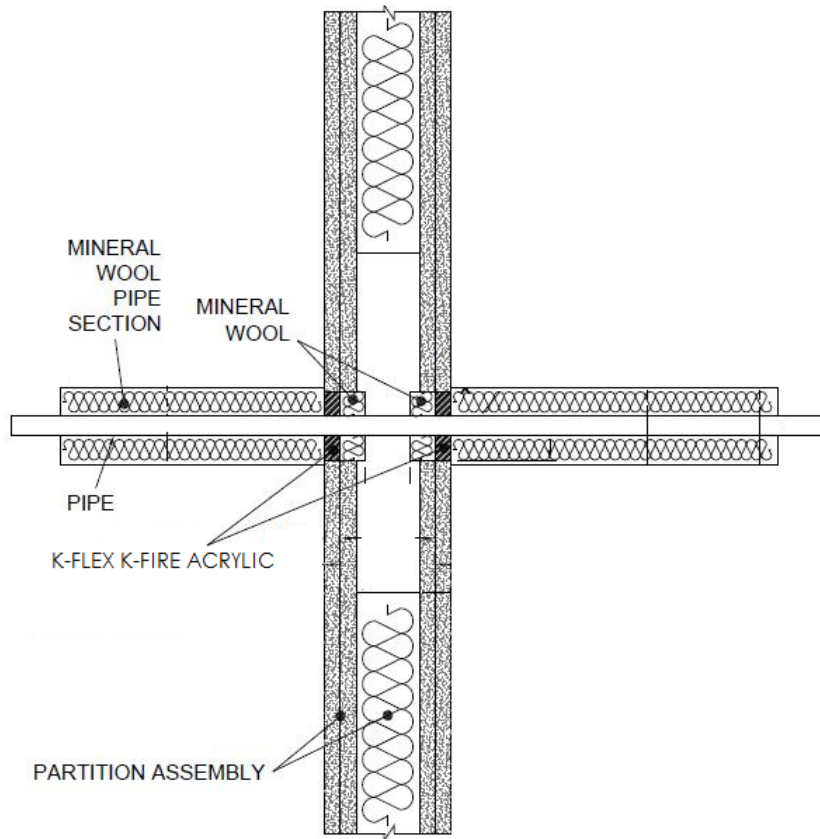

A.3.5.1

Services	Sealant depth	Backing	Insulation (minimum)	Classification
Maximum aperture size 300 x 300 mm				
Copper pipe up to 54 mm diameter/1-14.2 mm wall	12.5 mm	20 mm Stone wool 40 kg/m ³	500 mm length of 20 mm stone wool 80 kg/m ³	EI 120 C/U
Alupex composite pipe 75 mm diameter/7.5 mm wall		20 mm Stone wool 140 kg/m ³	600 mm length of 25 mm AES Fibre $\geq 128\text{kg/m}^3$	EI 60 C/U

Services	Sealant depth	Backing	Insulation (minimum)	Classification
Mild or stainless steel pipe				
Maximum aperture size 300 x 300 mm				
40 mm diameter/1-14.2 mm wall	12.5 mm	20mm Stone wool 40 kg/m ³	500 mm length of 20 mm stone wool 80 kg/m ³	EI 120 C/U
40 mm diameter/1-14.2 mm wall*			500 mm length of 30 mm stone wool 80 kg/m ³	
50 mm diameter/1.2-14.2 mm wall*				
60 mm diameter/1.4-14.2 mm wall*				
75 mm diameter/1.7-14.2 mm wall*				
90 mm diameter/2-14.2 mm wall*				
100 mm diameter/2.2-14.2 mm wall*				
115 mm diameter/2.5-14.2 mm wall*				
140 mm diameter/3-14.2 mm wall*	12.5 mm	20mm Stone wool 40 kg/m ³	500 mm length of 30 mm stone wool 80 kg/m ³	E 120, EI 90 C/U
165 mm diameter/3.5-14.2 mm wall*				
180 mm diameter/3.8-14.2 mm wall*				
200 mm diameter/4.2-14.2 mm wall*				
219 mm diameter/4.5-14.2 mm wall*				

* Typical pipe diameters shown, see below graph for intermediate sizes

Pipe diameter vs Wall thickness

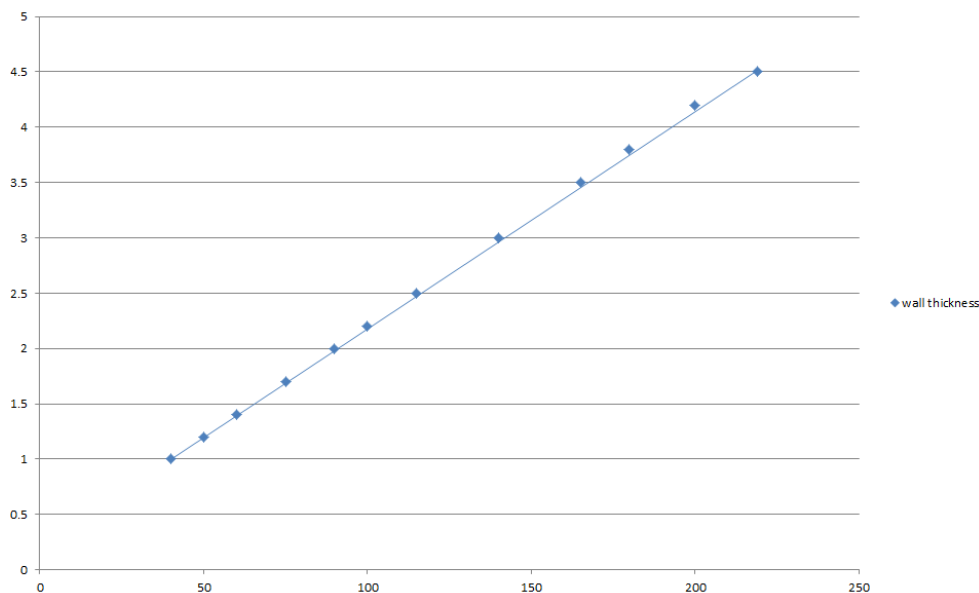

A.3.6 Double side penetration seal with plastic pipes

Penetration Seal: Combustible pipes (single) fitted at any position within the aperture, with K-FLEX K-FIRE ACRYLIC to both sides of the wall, 10 mm seal width around PVC pipes and 29 mm around PP pipes. No backing material is required but PE foam may be utilised.

Construction details:

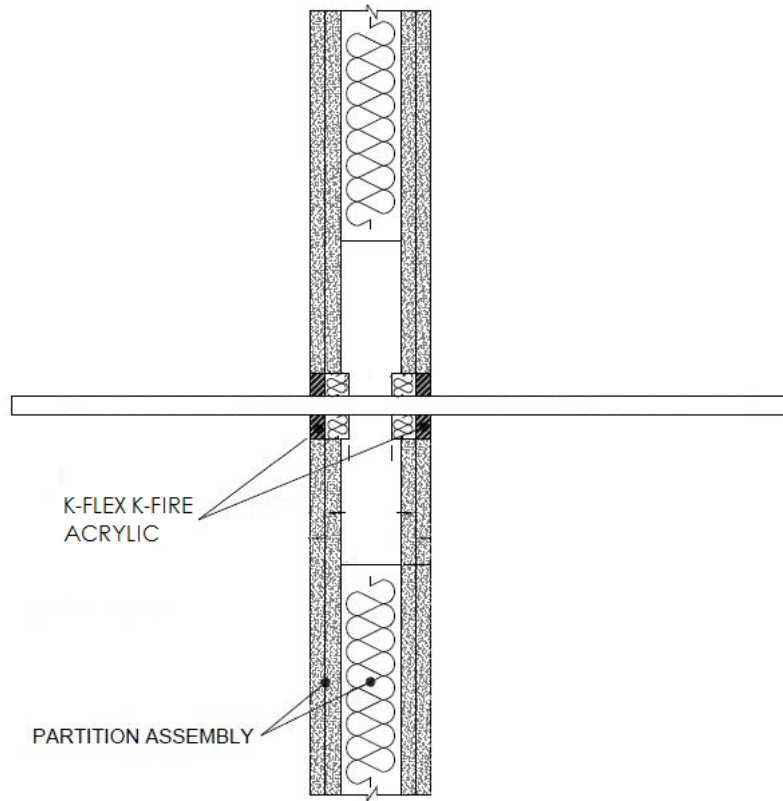

A.3.6.1

Services	Sealant depth	Backing	Aperture \varnothing	Classification
PVC-U pipe according to EN 1329-1, EN 1452-1 and EN 1453-1, PVC-C according to EN 1566-1* 32 mm \varnothing /1.7 mm wall	12.5 mm	None required	52 mm	EI 45 U/C, EI 45 C/C
	25 mm			EI 90 U/C, EI 90 C/C
PP pipe according to EN 1451-1 32 mm \varnothing /2 mm wall	25 mm		90 mm	

* In Germany the pipes have additionally to comply with DIN 19531-10

A.3.7 Double side penetration seal with plastic pipes

Penetration Seal: Combustible pipes (single) fitted at any position within the aperture, with K-FLEX K-FIRE ACRYLIC to both sides of the wall, Minimum annular space 10 mm and minimum separation between penetration seals 30 mm (A2).

Construction details:

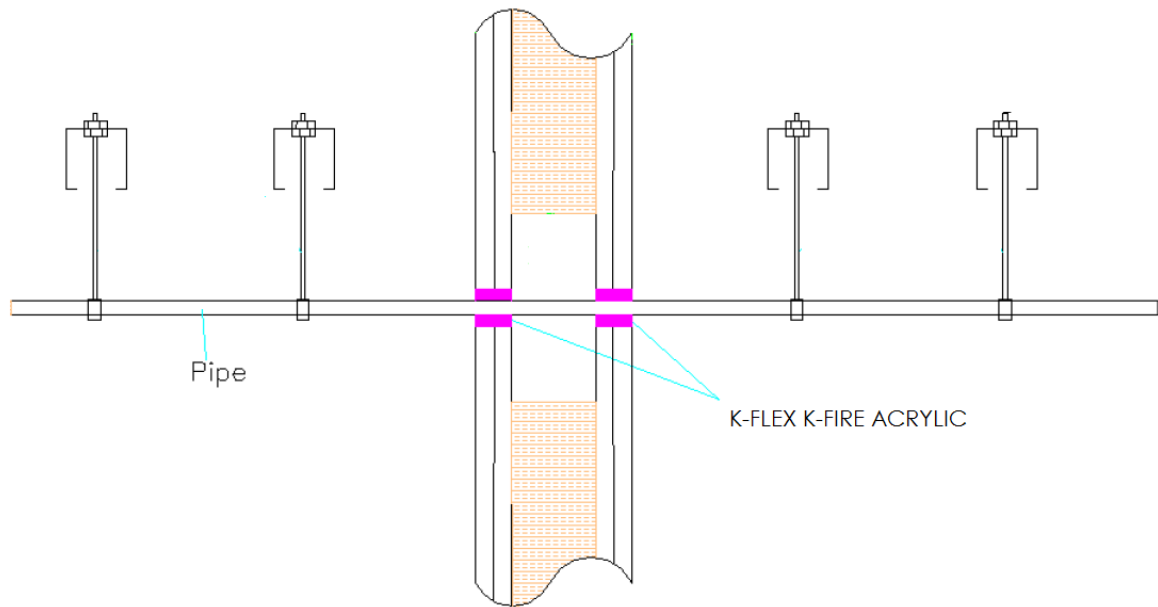

A.3.7.1

Pipe material	Sealant depth	Pipe size	Maximum Annular space	Classification	
PVC-U pipe according to EN 1329-1, EN 1452-1 and EN 1453-1, PVC-C according to EN 1566-1	25 mm	6-32 mm \varnothing /1.0-2.4 mm wall*	10 mm	EI 120 U/C	
			30 mm	E 120 U/C, EI 90 U/C	
PP pipe according to EN 1451-1		20 mm \varnothing /2.2 mm wall		30 mm	EI 120 U/C
		20 mm \varnothing /2.2-4.4 mm wall*	EI 60 U/C		
PE pipe according to EN 1519-1, EN 12201-2 and EN 12666-1, ABS according to EN 1455-1 and pipes made from SAN+PVC according to EN 1565-1		20 mm \varnothing /2.0 mm wall	20 mm \varnothing /2.0 mm wall	10 mm	EI 60 U/C
				30 mm	EI 120 U/C

* See below graphs for interpolated pipe sizes

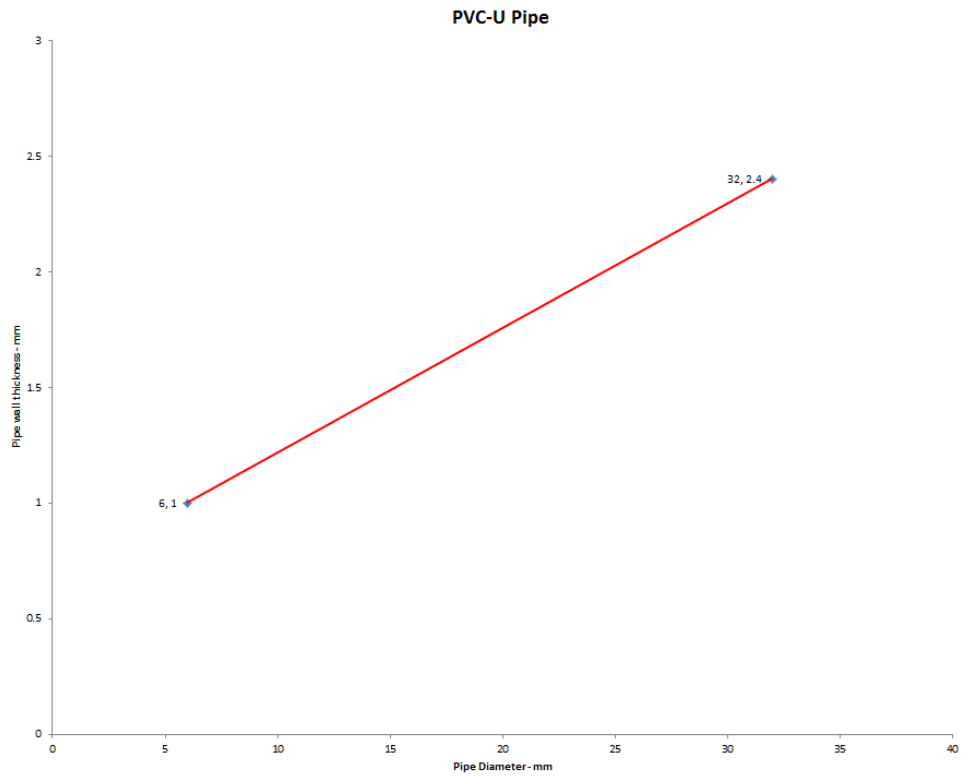

A.4 Rigid floor constructions according to 1.2.1 with floor thickness of minimum 150 mm

A.4.1 Single side penetration seal with cables

Penetration Seal: Cables (single) fitted at any position within the aperture, min. 30 mm from the edges, with K-FLEX K-FIRE ACRYLIC to either side of the floor (or at any position in between), backed with 'AES Fibre $\geq 128\text{kg/m}^3$ '.

Construction details:

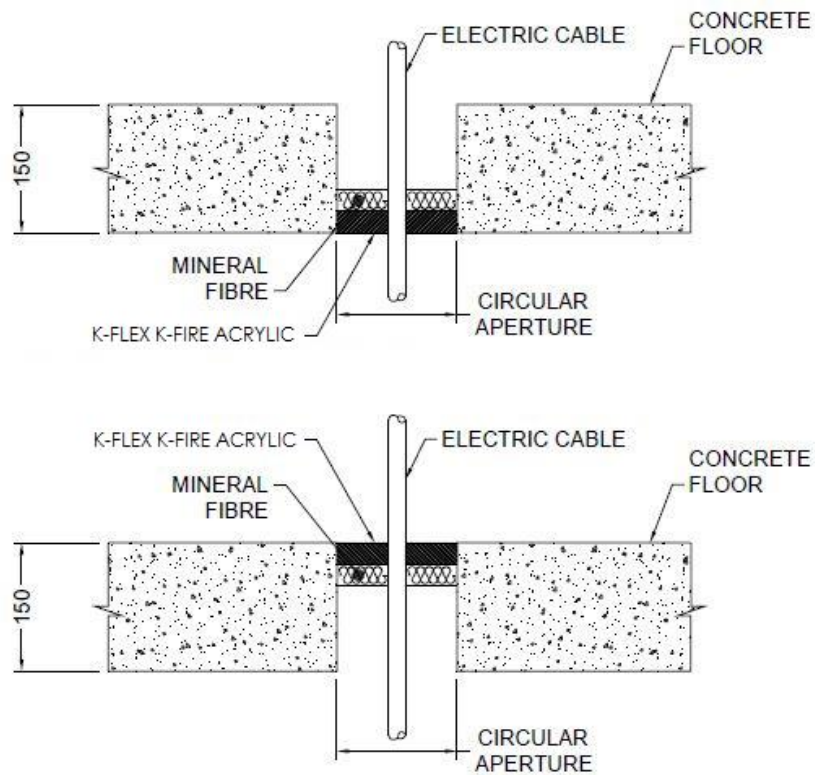

A.4.1.1

Services	Sealant depth	Backing	Aperture	Classification
Single electrical cables up to 21 mm \varnothing	25 mm	AES Fibre $\geq 128\text{kg/m}^3$ 25 mm deep	82 mm \varnothing or max. 100 x 1000 mm	E 120, EI 60

A.4.2 Single side penetration seal with cables

Penetration Seal: Cables fitted with K-FLEX K-FIRE ACRYLIC to the top side of the floor, backed with stone wool insulation 35kg/m^3 or AES Fibre $\geq 128\text{kg/m}^3$. Maximum seal size of 300×300 mm and minimum separation between cables and the edge of the seal of 10 mm.

Construction details:

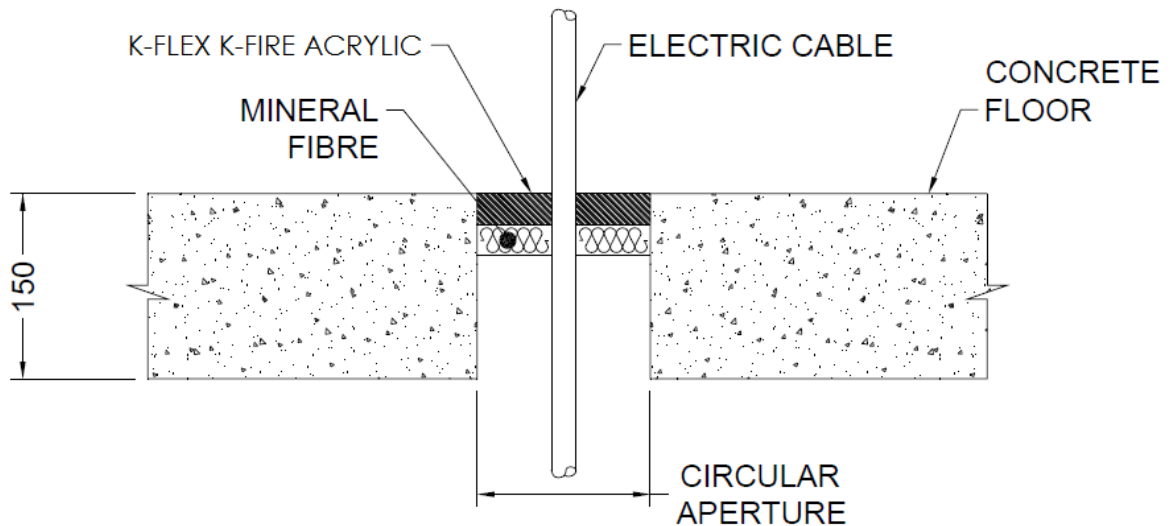

A.4.2.1

Services	Sealant depth	Backing	Insulation	Classification
Blank seals	15 mm	20 mm Stone wool 35 kg/m^3	None	E 90 EI 60
	25 mm	25 mm Stone wool 35 kg/m^3		EI 120
48 mm AES Fibre $\geq 128\text{kg/m}^3$		EI 240		
		E 120 EI 90		
Electric cables up to 21 mm diameter, single.	25 mm	48 mm AES Fibre $\geq 128\text{kg/m}^3$	E 120 EI 90	
23-27 mm diameter, 1 mm \times 185 mm ² core, PVC sheath and insulation electrical cable, single			EI 240	

A.4.3 Single side penetration seal with pipes

Penetration Seal: Pipes fitted at any position within the aperture, with K-FLEX K-FIRE ACRYLIC to the top face of the floor, backed with 48 mm stone wool 33kg/m³. Minimum annular space 10 mm (A1) and minimum separation between penetration seals 30 mm (A2), maximum seal size 300 x 300 mm / 300 mm diameter.

Construction details:

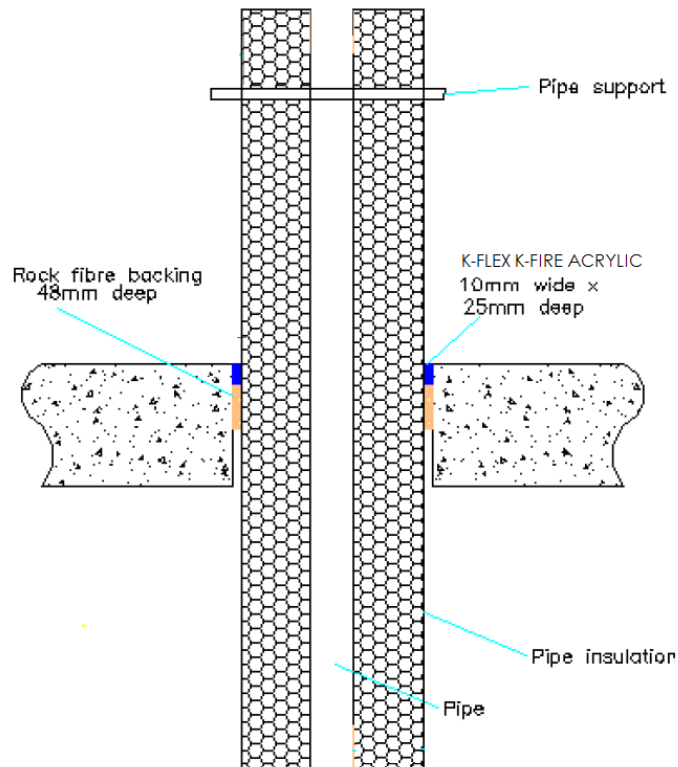

A.4.3.1

Services	Sealant depth	Backing	Classification
Mild or stainless steel pipe			
4 -16 mm diameter /1.0-8.0 mm wall	25 mm	48 mm stone wool	EI 120 C/U
Copper or steel pipe			
6 mm diameter /0.7-3.0 mm wall	25 mm	48 mm stone wool	EI 120 C/C
6 -15 mm diameter /0.7-7.5 mm wall			E 120 C/C, EI 60 C/C
Copper or steel pipe with 80 kg/m ³ density stone wool insulation Continuous Sustained (CS)			
12 mm diameter/0.9-6 mm wall, 20-80 mm insulation	25 mm	48 mm stone wool	EI 240 C/C
13-54 mm diameter/0.9-14.2 mm wall, 20-80 mm insulation*			E 240 C/C, EI 180 C/C
Alupex Pipe			
16 -20 mm diameter/2.0 mm wall	25 mm	48 mm stone wool	EI 120 C/C

*See below graphs for interpolated pipe sizes

Copper or Steel Pipe with 20-80 mm stone wool insulation CS - E 240 C/C, EI 180 C/C

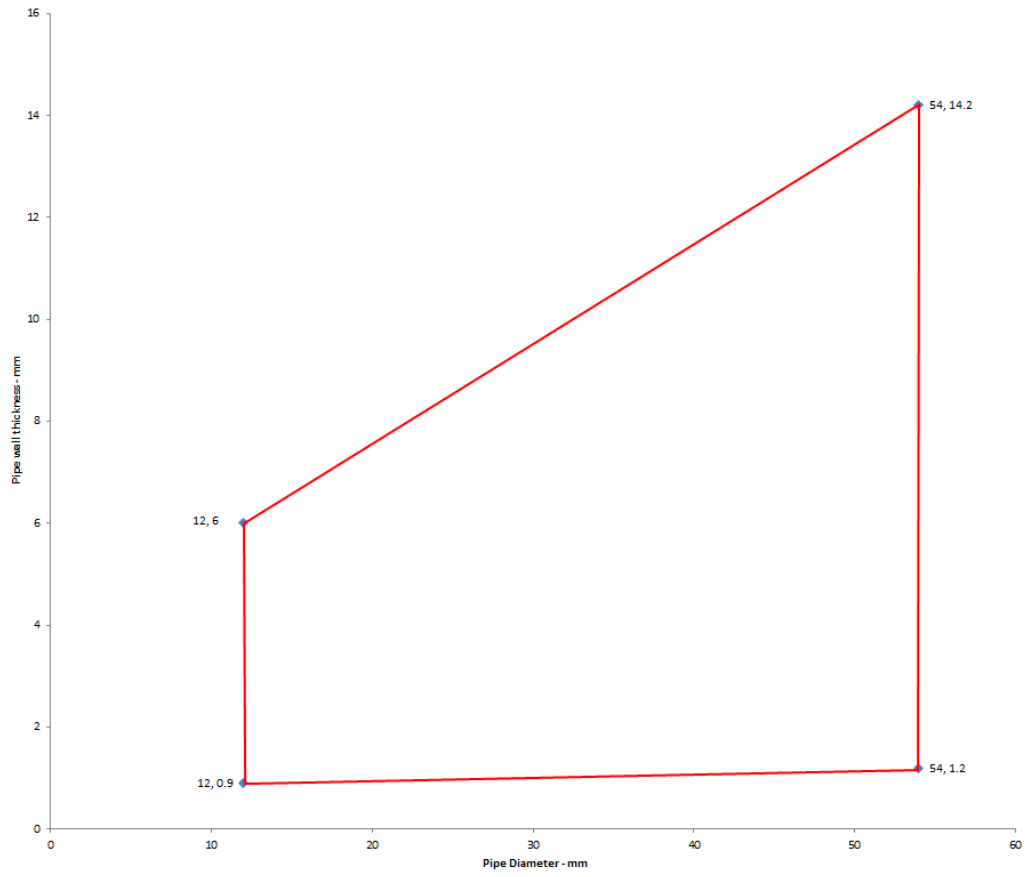

A.4.4 Double side penetration seal with pipes

Penetration Seal: Pipes fitted at any position within the aperture, with K-FLEX K-FIRE ACRYLIC to the both faces of the floor, backed with 25 mm stone wool 33kg/m³. Minimum annular space 10 mm (A1) and minimum separation between penetration seals 30 mm (A2), maximum seal size 300 x 300 mm / 300 mm diameter.

Construction details:

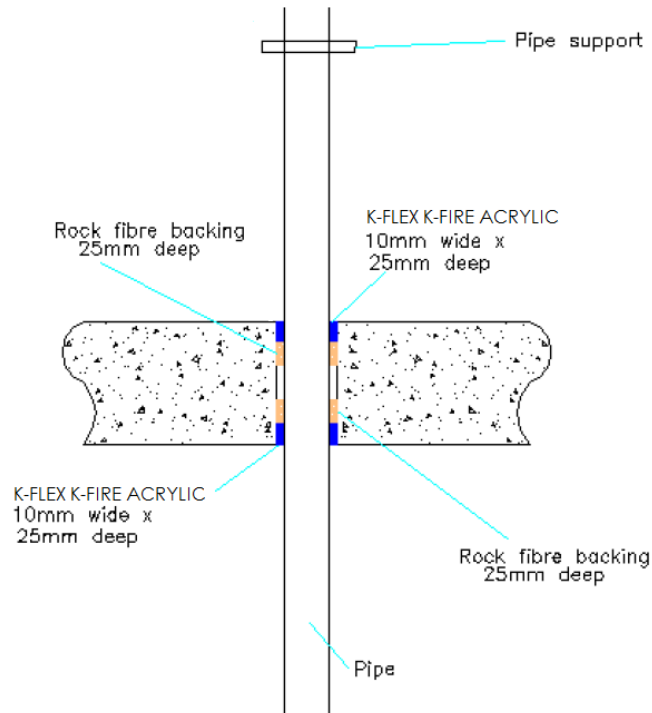

A.4.4.1

Services	Sealant depth	Backing	Classification
PVC-U pipe according to EN 1329-1, EN 1452-1 and EN 1453-1, PVC-C according to EN 1566-1			
Up to 50 mm \varnothing /1.6-3.7 mm wall	25 mm	25 mm Stone wool	EI 240 U/C
Up to 40 mm \varnothing /1.6-3.7 mm wall, with bundle of cables up to 21 mm diameter			
PP pipe according to EN 1451-1			
12 mm \varnothing /1.2 mm wall	25 mm	25 mm Stone wool	EI 240 U/C
13-75 mm \varnothing /1.2-6.8 mm wall*			EI 90 U/C
Up to 40 mm \varnothing /1.2-1.8 mm wall, with bundle of cables up to 21 mm diameter			EI 180 U/C
PE pipe according to EN 1519-1, EN 12201-2 and EN 12666-1, ABS according to EN 1455-1 and pipes made from SAN+PVC according to EN 1565-1			
20-40 mm \varnothing /2.0-2.4 mm wall*	25 mm	25 mm Stone wool	EI 240 U/C
Up to 40 mm \varnothing /2.0-2.4 mm wall, with bundle of cables up to 21 mm diameter			EI 180 U/C

*See below graphs for interpolated pipe sizes

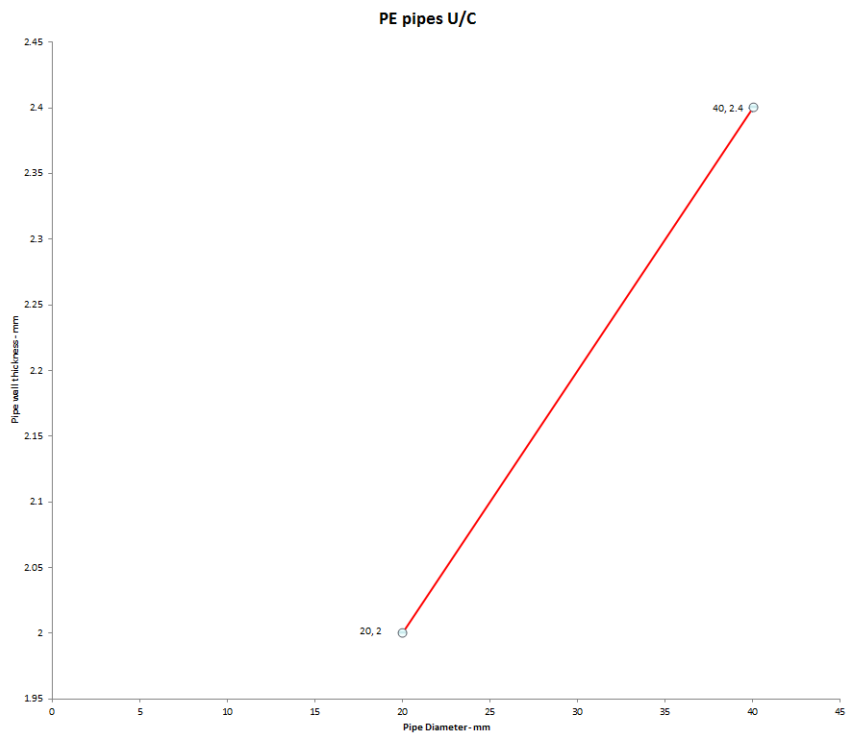
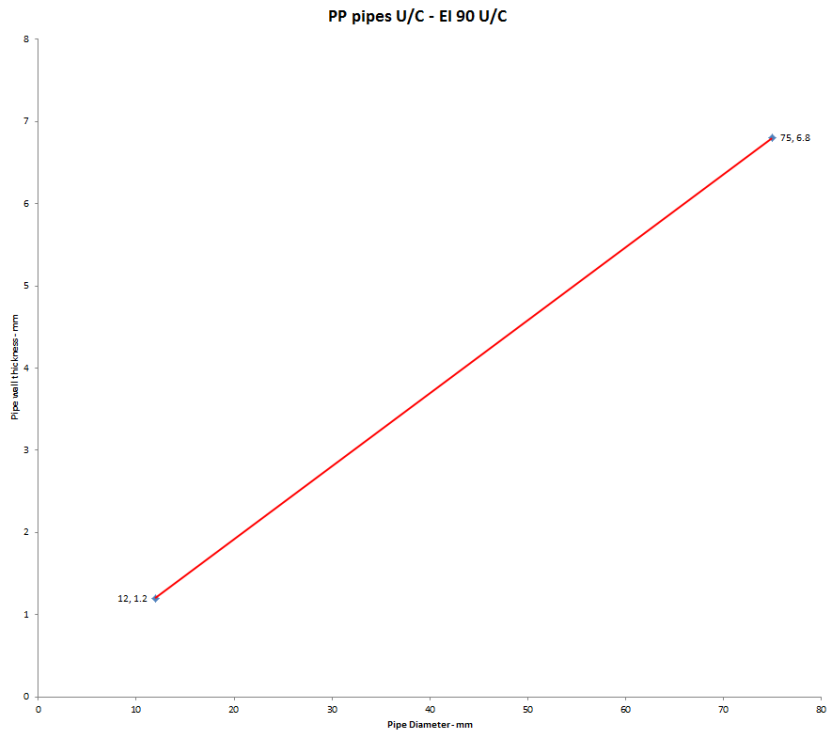

A.4.5 Double side penetration seal with cables

Penetration Seal: Cables fitted circular apertures or min. 7 mm from the edges of rectilinear apertures, with K-FLEX K-FIRE ACRYLIC to both sides of the floor, backed with stone wool insulation 35kg/m³.

Construction details:

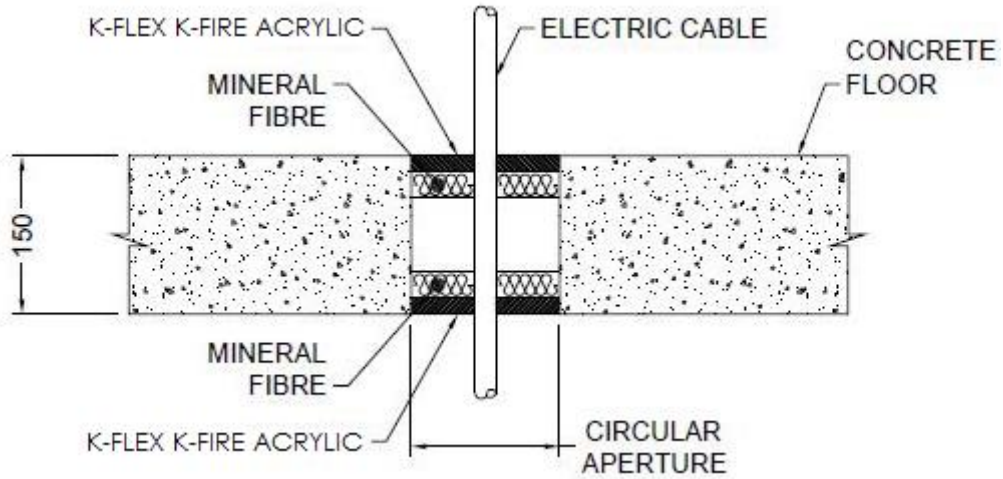

A.4.5.1

Services	Sealant depth	Backing	Maximum Aperture	Classification
Blank seals	15 mm	25 mm Stone wool 35 kg/m ³	300 x 300 mm	EI 240
Electric cables up to 21 mm diameter, single or in a bundle.				EI 120
Electric cables 22-50 mm diameter, single or in a bundle.				E 120 EI 90
Electric cables 51-80 mm diameter, single or in a bundle.				E 120 EI 60

A.4.6 Single side penetration seal with metallic pipes

Penetration Seal: 1000 mm (min.) LI (Local Interrupted) or CI (Continuous Interrupted) insulated metallic pipes (single) fitted at any position within the aperture, with 15 or 25 mm deep K-FLEX K-FIRE ACRYLIC to either side of the floor (or at any position between), backed with 40 kg/m³ stone wool insulation or AES Fibre ≥ 128kg/m³.

Construction details:

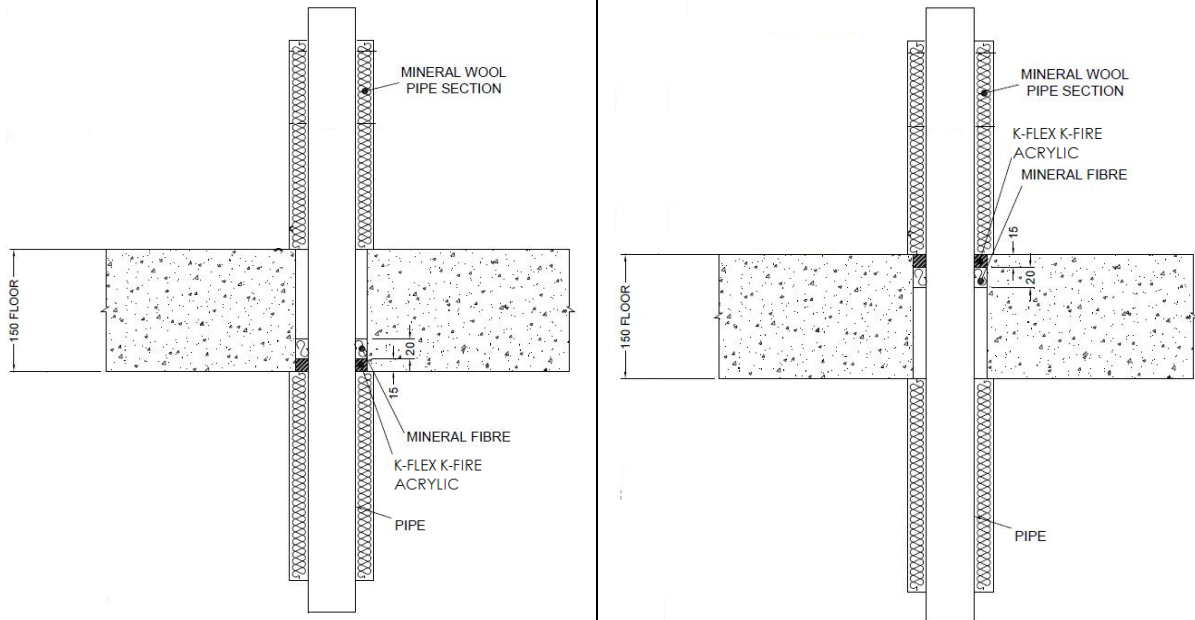

A.4.6.1

Services	Max. seal size	Insulation (min)	Sealant depth	Classification
Copper pipe up to 54 mm diameter/0.9-14.2 mm wall	10 mm width around pipe	20 mm Stone wool insulation 80 kg/m ³	15 mm	E 240 C/U, EI 180 C/U
Copper pipe up to 12 mm diameter/0.9-5 mm wall				EI 240 C/U
Copper pipe up to 54 mm diameter/0.9-14.2 mm wall	Up to 100 x 1000 mm		25 mm	EI 120 C/U
Copper pipe up to 54 mm diameter/0.9-14.2 mm wall	300 x 300 mm	20 mm Stone wool insulation 80 kg/m ³	15 mm	E 90 C/U, EI 60 C/U
Copper pipe up to 12 mm diameter/0.9-5 mm wall				EI 120 C/U
Copper pipe up to 54 mm diameter/0.9-14.2 mm wall			25 mm	EI 120 C/U

Services	Max. Seal Size	Insulation (min)	Sealant Depth	Classification
Mild or stainless steel pipe				
40 mm diameter/1-14.2 mm wall	10 mm width around pipe	20 mm Stone wool insulation 80 kg/m ³	15 mm	EI 240 C/U
40 mm diameter/1-14.2 mm wall*		30 mm Stone wool insulation 80 kg/m ³		E 240, EI 90 C/U
50 mm diameter/1.2-14.2 mm wall*				
60 mm diameter/1.4-14.2 mm wall*				
75 mm diameter/1.7-14.2 mm wall*				
90 mm diameter/2-14.2 mm wall*				
100 mm diameter/2.2-14.2 mm wall*				
115 mm diameter/2.5-14.2 mm wall*				
140 mm diameter/3-14.2 mm wall*				
165 mm diameter/3.5-14.2 mm wall*				
180 mm diameter/3.8-14.2 mm wall*				
200 mm diameter/4.2-14.2 mm wall*				
219 mm diameter/4.5-14.2 mm wall*				
40 mm diameter/1-14.2 mm wall*	Up to 100 x 1000 mm	20 mm Stone wool insulation 80 kg/m ³	25 mm	E120, EI 90 C/U
50 mm diameter/1.2-14.2 mm wall*		30 mm Stone wool insulation 80 kg/m ³		
60 mm diameter/1.4-14.2 mm wall*				
75 mm diameter/1.7-14.2 mm wall*				
90 mm diameter/2-14.2 mm wall*				
100 mm diameter/2.2-14.2 mm wall*				
115 mm diameter/2.5-14.2 mm wall*				
140 mm diameter/3-14.2 mm wall*				
165 mm diameter/3.5-14.2 mm wall*				
180 mm diameter/3.8-14.2 mm wall*				
200 mm diameter/4.2-14.2 mm wall*				
219 mm diameter/4.5-14.2 mm wall*				

* Typical pipe diameters shown, see below graph for intermediate sizes

Services	Max. Seal Size	Insulation (minimum)	Sealant Depth	Classification
Mild or stainless steel pipe				
40 mm diameter/1-14.2 mm wall	300 x 300 mm	20 mm Stone wool insulation 80 kg/m ³	15 mm	E 90 C/U, EI 60 C/U
40 mm diameter/1-14.2 mm wall*		30 mm Stone wool insulation 80 kg/m ³		
50 mm diameter/1.2-14.2 mm wall*				
60 mm diameter/1.4-14.2 mm wall*				
75 mm diameter/1.7-14.2 mm wall*				
90 mm diameter/2-14.2 mm wall*				
100 mm diameter/2.2-14.2 mm wall*				
115 mm diameter/2.5-14.2 mm wall*				
140 mm diameter/3-14.2 mm wall*				
165 mm diameter/3.5-14.2 mm wall*				
180 mm diameter/3.8-14.2 mm wall*				
200 mm diameter/4.2-14.2 mm wall*				
219 mm diameter/4.5-14.2 mm wall*				
40 mm diameter/1-14.2 mm wall*	300 x 300 mm		20 mm Stone wool insulation 80 kg/m ³	25 mm
50 mm diameter/1.2-14.2 mm wall*		30 mm Stone wool insulation 80 kg/m ³		
60 mm diameter/1.4-14.2 mm wall*				
75 mm diameter/1.7-14.2 mm wall*				
90 mm diameter/2-14.2 mm wall*				
100 mm diameter/2.2-14.2 mm wall*				
115 mm diameter/2.5-14.2 mm wall*				
140 mm diameter/3-14.2 mm wall*				
165 mm diameter/3.5-14.2 mm wall*				
180 mm diameter/3.8-14.2 mm wall*				
200 mm diameter/4.2-14.2 mm wall*				
219 mm diameter/4.5-14.2 mm wall*				

* Typical pipe diameters shown, see below graph for intermediate sizes

Pipe diameter vs Wall thickness

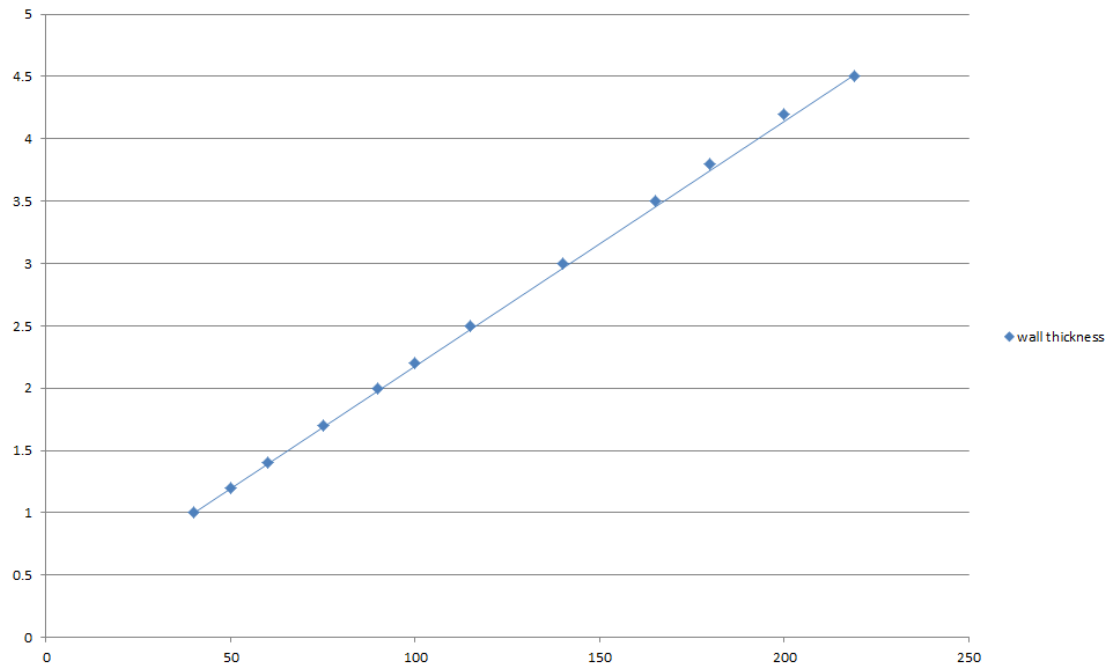

A.4.7 Single side penetration seal with metallic pipes

Penetration Seal: CS (Continuous Sustained) insulated metallic pipes (single) fitted at any position within the aperture, with 25 mm K-FLEX K-FIRE ACRYLIC to the top of the floor, backed with 48 mm deep AES Fibre $\geq 128\text{kg/m}^3$ insulation. Minimum annular space 10 mm (A1) and minimum separation between penetration seals 30 mm (A2). Maximum seal size 300 x 300 mm / 504 mm \varnothing

Construction details:

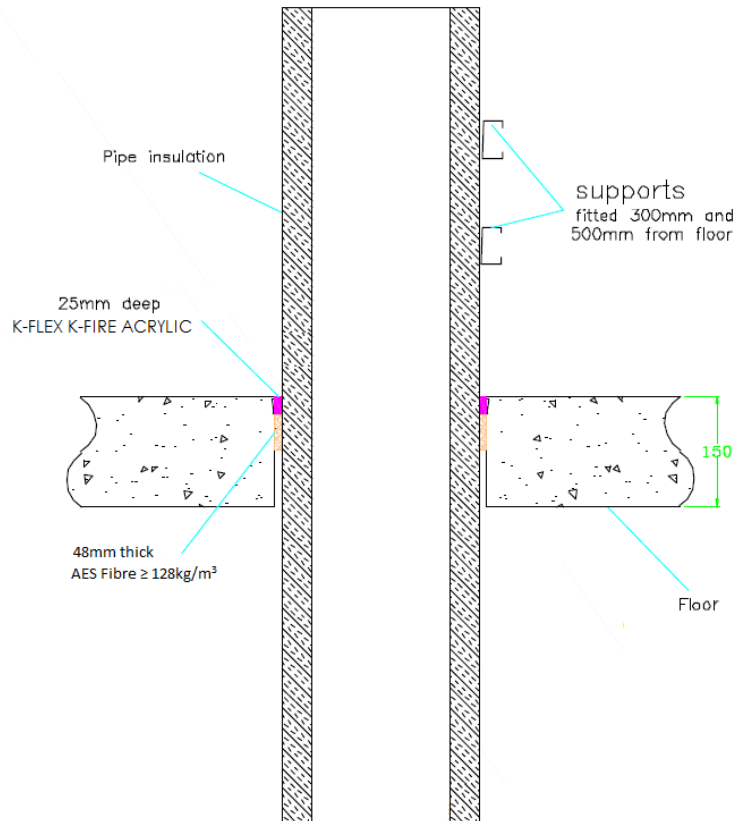

Configuration 1

Option 1

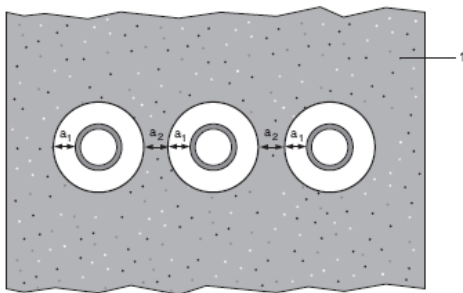

Configuration 2

Option 2

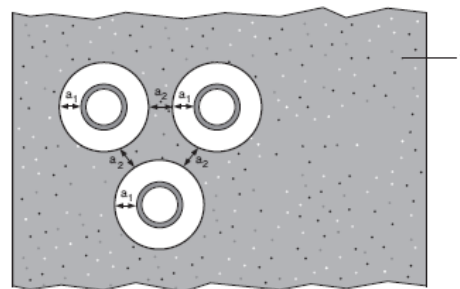

Key

1 Supporting construction

a1 Pipe / top edge of seal separation

a2 Pipe / side edge of seal separation

a3 Pipe / pipe separation

A.4.7.1 Single side penetration seal with pipes

Mild or stainless steel pipe	Insulation	Classification
40 mm diameter/1-14.2 mm wall	20 mm thick stone, mineral wool min. 80 kg/m ³	EI 240 C/U
40 mm diameter/1-14.2 mm wall*	30-80 mm thick stone, mineral wool min. 80 kg/m ³	
50 mm diameter/1.2-14.2 mm wall*		
60 mm diameter/1.4-14.2 mm wall*		
75 mm diameter/1.6-14.2 mm wall*		
90 mm diameter/1.9-14.2 mm wall*		
100 mm diameter/2.1-14.2 mm wall*		
115 mm diameter/2.4-14.2 mm wall*		
140 mm diameter/2.9-14.2 mm wall*		
165 mm diameter/ 3.4-14.2 mm wall*		
180 mm diameter/ 3.6-14.2 mm wall*		
200 mm diameter/ 4.0-14.2 mm wall*		
219 mm diameter/ 4.3-14.2 mm wall*		
250 mm diameter/ 5.0-14.2 mm wall*		
300 mm diameter/ 5.9-14.2 mm wall*		
324 mm diameter/ 6.35-14.2 mm wall*		
PEX pipe in pipe system	Insulation	Classification
15 mm diameter x 2.5 mm wall inner /25mm diameter outer	None	EI 90 C/C

Pipe Diameter vs wall thickness

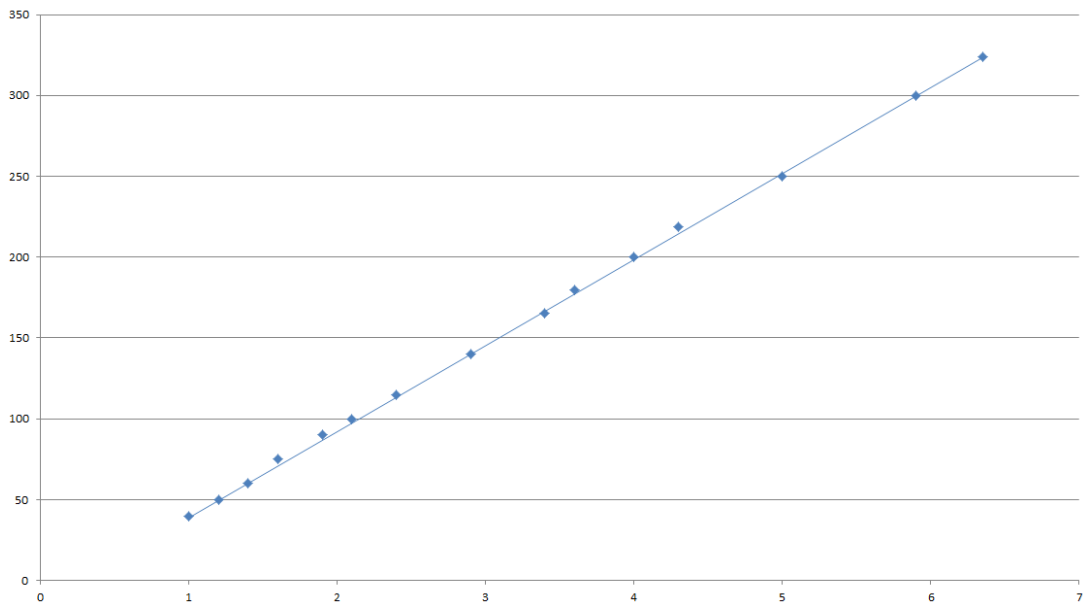

A.4.8 Single side penetration seal with composite pipes

Penetration Seal: CI (Continuous Interrupted) insulated composite pipes (single) fitted at any position within the aperture, with K-FLEX K-FIRE ACRYLIC, minimum 10 mm seal width around service and maximum 300 x 300 mm seal, backed with 'AES Fibre $\geq 128\text{kg/m}^3$ '.

Construction details:

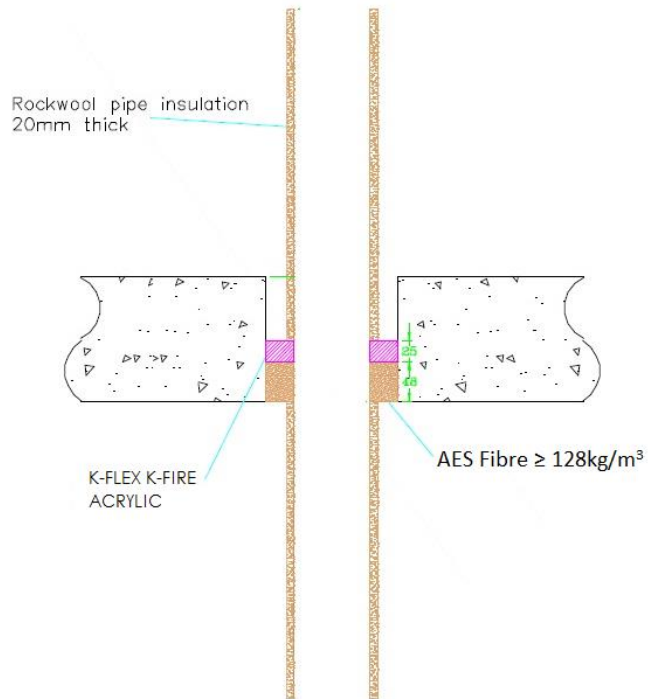

A.4.8.1

Services	Sealant depth	Backing	Insulation (minimums)	Classification
Alupex Composite Pipe	25 mm	48 mm AES Fibre $\geq 128\text{kg/m}^3$	20 mm stonewool 80 kg/m^3 , 500 mm length from both sides of the seal	EI 240 C/C
16 mm diameter/2.25 mm wall				
20 mm diameter/2.5 mm wall				
26 mm diameter/3 mm wall				
32 mm diameter/3 mm wall				
40 mm diameter/3.5 mm wall				
50 mm diameter/4 mm wall				
63 mm diameter/4.5 mm wall				
75 mm diameter/4.7 mm wall				

A.4.9 Double side penetration seal with metallic pipes

Penetration Seal: Non-insulated metallic pipes (single) fitted at any position within the aperture, with 25 mm deep K-FLEX K-FIRE ACRYLIC to both sides of the floor, backed with 25 mm deep 140 kg/m³ stone wool insulation.

Construction details:

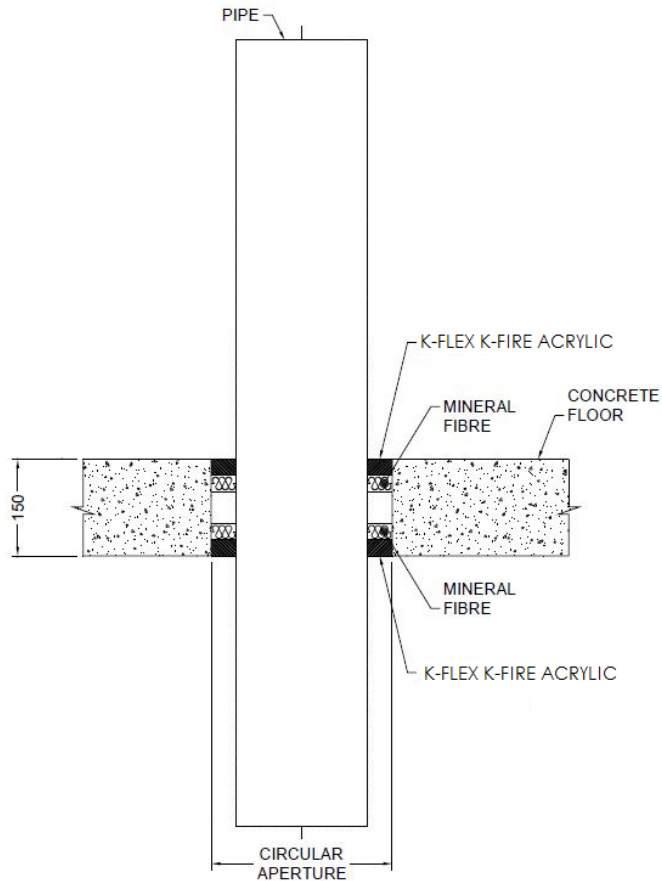

A.4.9.1

Services	Max. Seal Size	Insulation	Backing	Classification
Copper pipe 54 mm diameter/2-14.2 mm wall	300 x 300 mm	None	25 mm deep 140 kg/m ³ stone wool	E 120 C/U, EI 20 C/U
Mild steel pipe 16 mm diameter/1.5-7.5 mm wall				EI 240 C/U
Mild steel pipe 16 mm diameter/1.5-7.5 mm wall	Up to 100 x 1000 mm		AES Fibre ≥ 128kg/m ³ 25 mm deep	EI 120 C/U

A.4.10 Double side penetration seal with metallic pipes

Penetration Seal: CS (Continuous Sustained) insulated metallic pipes (single) fitted at any position within the aperture, with K-FLEX K-FIRE ACRYLIC to both sides of the wall, maximum 300 x 300 mm seal width around service, backed with stone wool insulation or 'AES Fibre $\geq 128\text{kg/m}^3$ '.

Construction details:

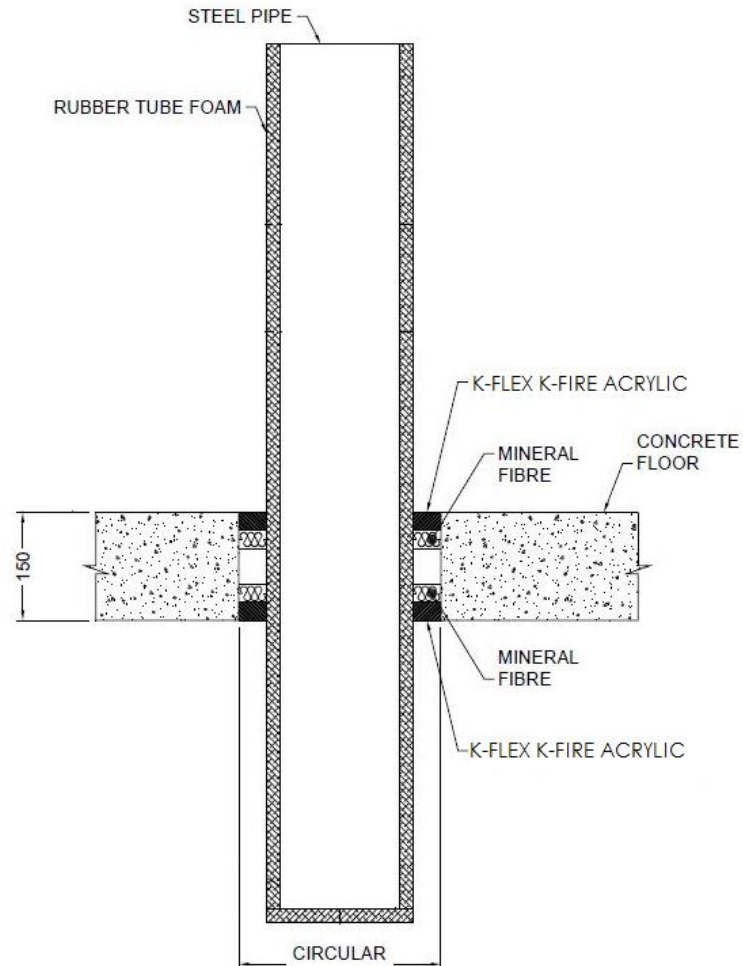

A.4.10.1

Services	Sealant depth	Backing	Insulation	Classification
Mild or stainless steel pipe				
40 mm diameter/1-14.2 mm wall	25 mm	20 mm Stone wool 40 kg/m ³		EI 180
40 mm diameter/1-14.2 mm wall*	25 mm	25 mm AES Fibre ≥ 128kg/m ³	13 -19 mm Elastomeric insulation minimum class B-s3,d0	EI 60
50 mm diameter/1.3-14.2 mm wall*				
60 mm diameter/1.6-14.2 mm wall*				
75 mm diameter/2-14.2 mm wall*				
90 mm diameter/2.4-14.2 mm wall*				
100 mm diameter/2.7-14.2 mm wall*				
115 mm diameter/3.1-14.2 mm wall*				
140 mm diameter/3.8-14.2 mm wall*				
165 mm diameter/ 4.5-14.2 mm wall*				

* Typical pipe diameters shown, see below graph for intermediate sizes

Pipe diameter vs Wall thickness

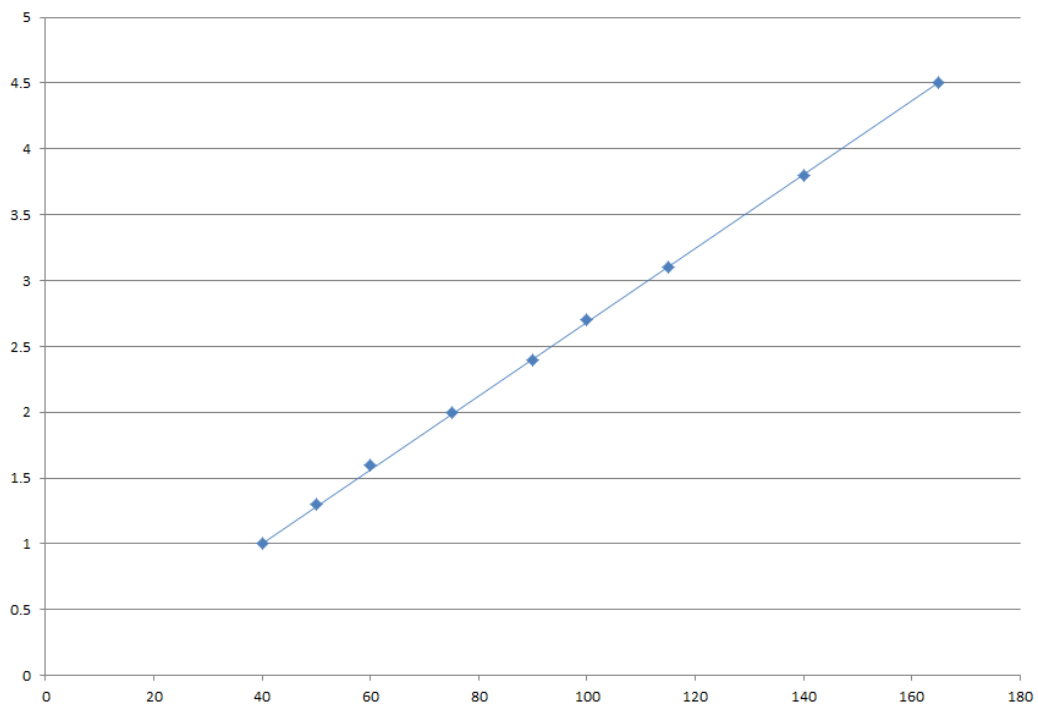

Services	Sealant depth	Backing	Insulation	Classification
Copper pipe				
12 mm diameter/1 mm wall	25 mm	25 mm AES Fibre \geq 128kg/m ³	9 mm Elastomeric insulation minimum class B-s3,d0	E 240 C/C, EI 180 C/C
12-54 mm diameter/1-1.2 mm wall			9-13 mm Elastomeric insulation minimum class B-s3,d0	E 180, EI 120 C/C
12-54 mm diameter/1-1.2 mm wall			13-25 mm Elastomeric insulation minimum class B-s3,d0	E 90 C/C, EI 60 C/C
Alupex Composite Pipe				
16 mm diameter/2.25 mm wall	25 mm	25 mm AES Fibre \geq 128kg/m ³	9 mm Elastomeric insulation minimum class B-s3,d0	EI 180 C/C
16 mm diameter/2.25 mm wall			9-13 mm Elastomeric insulation minimum class B-s3,d0	E 120 C/C, EI 60 C/C
20 mm diameter/2.5 mm wall				
26 mm diameter/3 mm wall				
32 mm diameter/3 mm wall				
40 mm diameter/3.5 mm wall				
50 mm diameter/4 mm wall				
63 mm diameter/4.5 mm wall				
75 mm diameter/4.7 mm wall				
16 mm diameter/2.25 mm wall			13-25 mm Elastomeric insulation minimum class B-s3,d0	EI 60 C/C
20 mm diameter/2.5 mm wall				
26 mm diameter/3 mm wall				
32 mm diameter/3 mm wall				
40 mm diameter/3.5 mm wall				
50 mm diameter/4 mm wall				
63 mm diameter/4.5 mm wall				
75 mm diameter/4.7 mm wall				

A.4.11 Double side penetration seal with metallic pipes

Penetration Seal: 1000 mm (min.) LI (Local Interrupted) or CI (Continuous Interrupted) insulated metallic pipes (single) fitted at any position within the aperture, with 15 mm deep K-FLEX K-FIRE ACRYLIC to both sides of the floor (or at any position between), backed with 20 or 30 mm deep 40 kg/m³ stone wool insulation*.

Construction details:

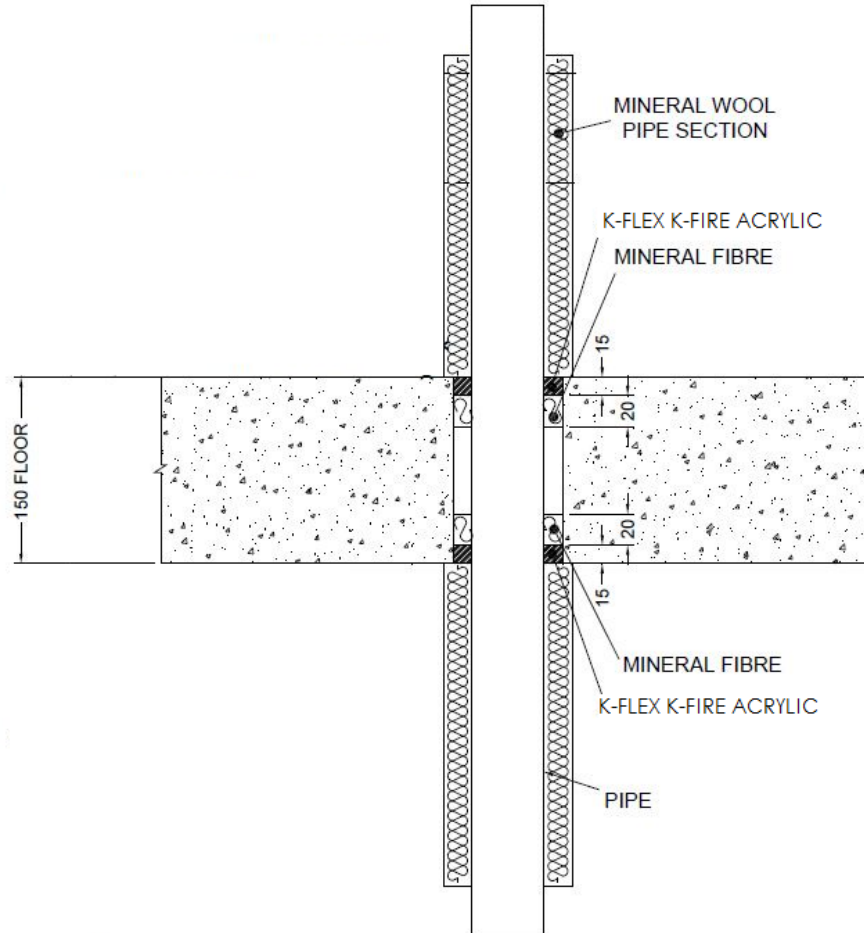

A.4.11.1

Services	Maximum seal size	Insulation (minimum)	Classification
Mild or stainless steel pipe			
40 mm diameter/1-14.2 mm wall	300 x 300 mm or 100 x 1000 mm	20 mm Stone wool insulation 80 kg/m ³	EI 240 C/U
40 mm diameter/1-14.2 mm wall*		30 mm Stone wool insulation 80 kg/m ³	E 240, EI 120 C/U
50 mm diameter/1.2-14.2 mm wall*			
60 mm diameter/1.4-14.2 mm wall*			
75 mm diameter/1.7-14.2 mm wall*			
90 mm diameter/2-14.2 mm wall*			
100 mm diameter/2.2-14.2 mm wall*			
115 mm diameter/2.5-14.2 mm wall*			
140 mm diameter/3-14.2 mm wall*			
165 mm diameter/3.5-14.2 mm wall*			
180 mm diameter/3.8-14.2 mm wall*			
200 mm diameter/4.2-14.2 mm wall*			
219 mm diameter/4.5-14.2 mm wall*			

* Typical pipe diameters shown, see below graph for intermediate sizes

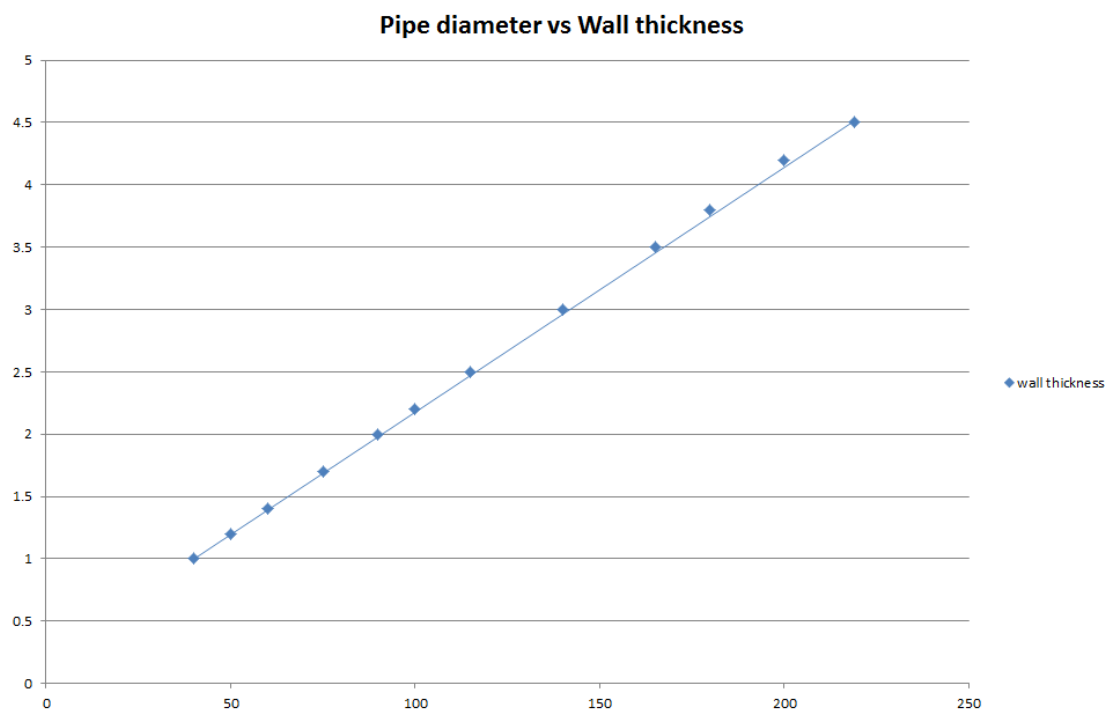

A.4.12 Double side penetration seal with plastic pipes

Penetration Seal: Combustible pipes sealed with K-FLEX K-FIRE ACRYLIC, to both sides of the floor backed with Stonewool (35kg/m³ density), 25 mm deep. Minimum separation between penetration seals of 30 mm (a_2) and seal size/annular space of 10-30 mm (a_1).

Construction details:

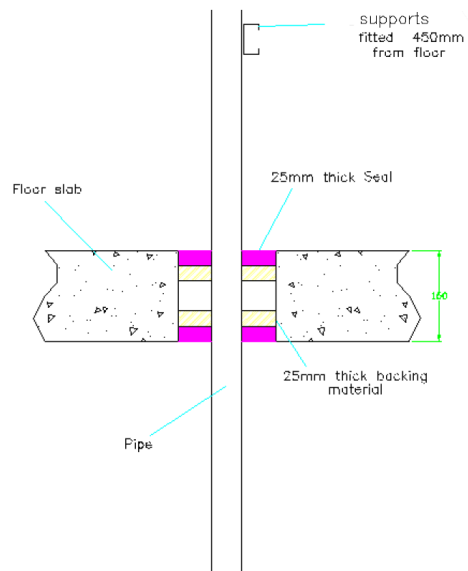

Configuration 1

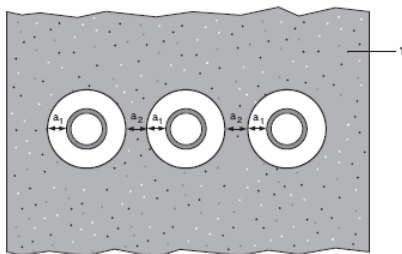

Configuration 2

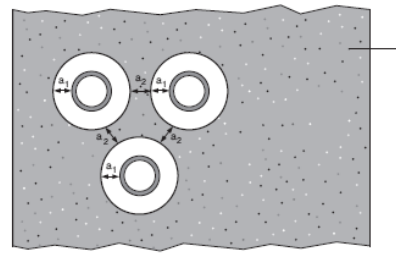

Key

1 Supporting construction

a_1 Pipe / edge of seal separation (annular space)

a_2 Separation between penetration seals

A.4.12.1

Services	Sealant depth	Backing	Classification
PP pipe according to EN 1451-1	25 mm	25 mm AES Fibre \geq 128kg/m ³	EI 120 U/C, EI 120 C/C
40 mm \emptyset /3 mm wall			
75 mm \emptyset /2.8 mm wall		25 mm stone wool 140 kg/m ³	EI 180 U/C, EI 180 C/C
PE (PE-HD) pipe according to EN 1519-1, EN 12201-2 and EN 12666-1, ABS according to EN 1455-1 and pipes made from SAN+PVC according to EN 1565-1 40 mm \emptyset /4 mm wall	EI 240 U/C, EI 240 C/C		